



**Module for emergency stops, end position monitoring for movable guards with delayed contacts at the opening of the input channels, OSSD semiconductor outputs and magnetic safety sensors**

**Main features**

- For safety applications up to SIL CL 3/PL e
- Input with 1 or 2 channels
- Choice between automatic start, manual start or monitored start
- Connection of input channels of opposite potentials
- Can be connected to OSSD semiconductor outputs, to electromechanical contacts or to magnetic safety sensors
- Standard housing width of 45 mm
- 2 instantaneous NO safety contacts, 1 instantaneous NC auxiliary contact, 2 delayed NO safety contacts.
- Supply voltage: 24 Vac/dc, 120 Vac, 230 Vac

**Utilization categories**

Alternating current: AC15 (50...60 Hz)

U<sub>e</sub> (V) 230

I<sub>e</sub> (A) 3

Direct current: DC13 (6 oper. cycles/min.)

U<sub>e</sub> (V) 24

I<sub>e</sub> (A) 4

**Quality marks:**



EC type examination certificate: IMQ CP 432 DM

UL approval: E131787

CCC approval: 2013010305640211

EAC approval: RU C-IT.AQ35.B.00454

**Compliance with the requirements of:**

Machinery Directive 2006/42/EC, EMC Directive 2014/30/EC, RoHS Directive 2011/65/EU.

**Technical data**

**Housing**

Polyamide housing PA 66, self-extinguishing V0 acc. to UL 94

Protection degree acc. to EN 60529:

IP40 (housing), IP20 (terminal strip)

Dimensions:

see page 317, design C

**General data**

SIL level (SIL CL) up to:

SIL CL 3 acc. to EN 62061

Performance Level (PL) up to:

PL e acc. to EN ISO 13849-1

Safety category up to:

category 4 (instantaneous contacts),

category 3 (delayed contacts)

acc. to EN ISO 13849-1

see page 375

Safety parameters:

Ambient temperature:

-25°C...+55°C

Mechanical endurance:

> 10 million operating cycles

Electrical endurance:

> 100,000 operating cycles

Pollution degree:

external 3, internal 2

Rated impulse withstand voltage (U<sub>imp</sub>):

4 kV

Rated insulation voltage (U<sub>i</sub>):

250 V

Overvoltage category:

II

**Supply**

Rated supply voltage (U<sub>n</sub>):

24 Vac/dc; 50...60 Hz

120 Vac; 50...60 Hz

230 Vac; 50...60 Hz

Max. DC residual ripple in DC:

10%

Supply voltage tolerance:

±15% of U<sub>n</sub>

Power consumption AC:

< 10 VA

Power consumption DC:

< 5 W

**Control circuit**

Protection against short circuits:

PTC resistance, I<sub>h</sub>=0.5 A

PTC times:

Response time > 100 ms, release time > 3 s

Maximum resistance per input:

≤ 50 Ω

Current per input:

30 mA (typical)

Min. duration of start impulse t<sub>MIN</sub>:

> 200 ms

Response time t<sub>A</sub>:

< 150 ms

Release time t<sub>R1</sub>:

< 25 ms

Release time in absence of power supply t<sub>R</sub>:

< 150 ms

Release time, delayed contacts t<sub>R2</sub>:

see "Code structure"

Simultaneity time t<sub>C</sub>:

unlimited

**In compliance with standards:**

EN 60204-1, EN ISO 13855, EN 1037, EN ISO 12100, EN ISO 13850, EN 60529, EN 61000-6-2, EN 61000-6-3, EN 61326-1, EN 60664-1, EN 60947-1, EN 50581, EN ISO 13849-1, EN ISO 13849-2, EN 62061, UL 508, CSA C22.2 n° 14-95, GB/T 14048.5-2017

**Output circuit**

Output contacts:

2 instantaneous NO safety contacts,

1 instantaneous NC auxiliary contact,

2 delayed NO safety contacts.

Contact type:

forcibly guided

Material of the contacts:

gold-plated silver alloy

Maximum switching voltage:

230/240 Vac; 300 Vdc

Max. current per contact:

6 A

Conventional free air thermal current I<sub>th</sub>:

6 A

Max. total current Σ I<sub>th</sub><sup>2</sup>:

72 (instant. contacts), 36 (del. contacts) A<sup>2</sup>

Minimum current:

10 mA

Contact resistance:

≤ 100 mΩ

External protection fuse:

4 A

The number and the load capacity of output contacts can be increased by using expansion modules or contactors. See pages 263-272.

**Code structure**

article options  
**CS AT-00V024-TF1**

Release time, delayed contacts (t<sub>R2</sub>)

<b>0</b>	Fixed time (see TF)
<b>1</b>	0.3 ... 3 s, 0.3 s steps
<b>2</b>	1 ... 10 s, 1 s steps
<b>3</b>	3 ... 30 s, 3 s steps
<b>4</b>	30 ... 300 s, 30 s steps

Release time, delayed contacts (t<sub>R2</sub>)

<b>TF0.5</b>	0.5 s fixed time
<b>TF1</b>	1 s fixed time
<b>TF3</b>	3 s fixed time
...	.....

Supply voltage

<b>024</b>	24 Vac/dc
<b>120</b>	120 Vac
<b>230</b>	230 Vac

Connection type

<b>V</b>	Screw terminals
<b>M</b>	Connector with screw terminals
<b>X</b>	Connector with spring terminals

**Features approved by UL**

Rated supply voltage (U <sub>n</sub> ):	24 Vac/dc; 50...60 Hz 120 Vac; 50...60 Hz 230 Vac; 50...60 Hz
Power consumption AC:	< 10 VA
Power consumption DC:	< 4 W
Electrical ratings:	230/240 Vac 6 A general use C300 pilot duty

Notes:

- Use 60 or 75°C copper (Cu) conductor and wire size No. 30-12 AWG, stranded or solid.
- The terminal tightening torque of 5-7 lb in.
- Only for 24 Vac/dc versions: supply from remote Class 2 source or limited voltage limited energy.
- Surrounding air of 55°C.



### Safety module CS AT-0

#### Pin assignment

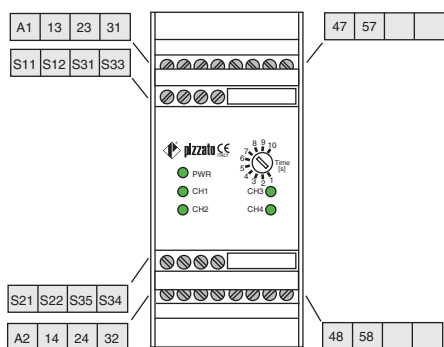

#### Internal block diagram

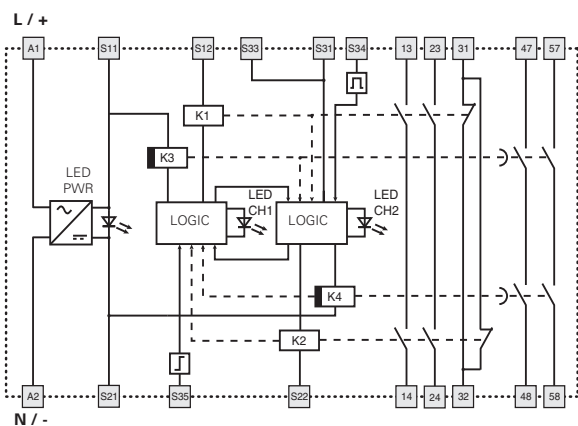

#### Input configuration

OSSD semiconductor outputs (e.g. ST, NS, NG series or light barriers)  
 Input configuration with manual start

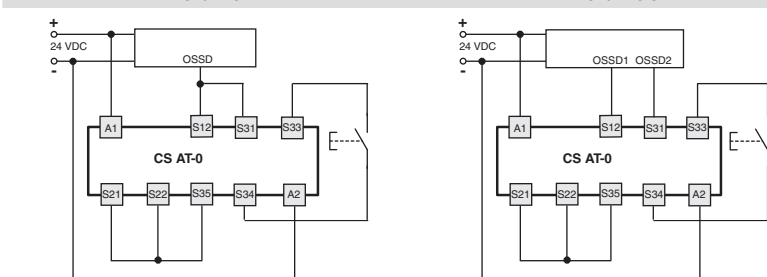

Emergency stop circuits  
 Input configuration with manual start

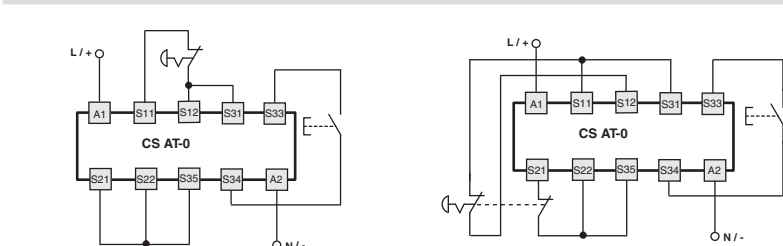

#### Function diagrams

Configuration with automatic start

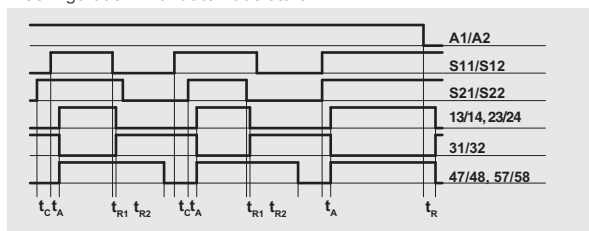

Configuration with monitored start

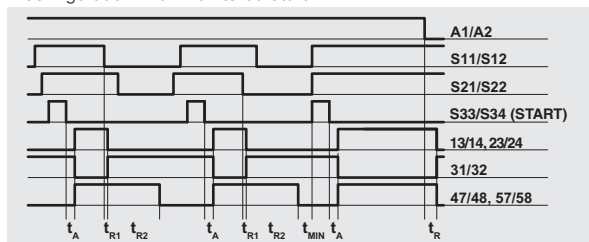

Configuration with manual start

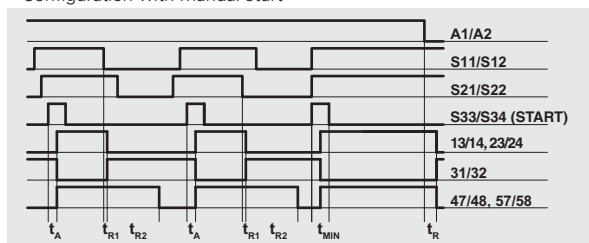

- Legend:
- $t_{MIN}$ : Min. duration of start impulse
  - $t_c$ : simultaneity time
  - $t_r$ : response time
  - $t_{r1}$ : release time
  - $t_{r2}$ : release time in absence of power supply
  - $t_{r2}$ : release time, delayed contacts adjustable (see "Code structure")

Notes:  
 The configurations with one channel are obtained taking into consideration the S11/S12 input only. In this case it is necessary to consider time  $t_{r1}$  and  $t_{r2}$  referred to input S11/S12, time  $t_r$  referred to the supply, time  $t_A$  referred to input S11/S12 and to the start, and time  $t_{MIN}$  referred to the start.

#### Automatic start

With regard to the indicated diagrams, bridge the start button between S33 and S34 in order to activate the automatic start module.

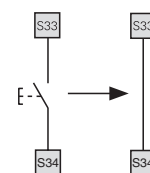

#### Monitored start

With regard to the indicated diagrams, remove the connection between S22 and S35 in order to activate the monitored start module.

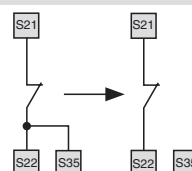

#### Monitoring of movable guards and magnetic safety sensors

The safety module can monitor emergency stop circuits, control circuits for movable guards as well as magnetic safety sensors. Replace the emergency stop contacts with switch contacts or sensor contacts. The sensors can only be used in 2-channel configuration.

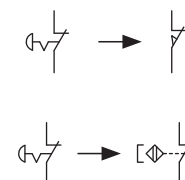

The diagram does not show the exact position of the terminals in the product



**Module for emergency stops, end position monitoring for movable guards with delayed contacts at the opening of the input channels, OSSD semiconductor outputs and magnetic safety sensors**

#### Main features

- For safety applications up to SIL CL 3/PL e
- Input with 1 or 2 channels
- Choice between automatic start, manual start or monitored start
- Connection of input channels of opposite potentials
- Can be connected to OSSD semiconductor outputs, to electromechanical contacts or to magnetic safety sensors
- Standard housing width of 45 mm
- 3 instantaneous NO safety contacts, 2 delayed NO safety contacts.
- Supply voltage:  
24 Vac/dc, 120 Vac, 230 Vac

#### Utilization categories

Alternating current: AC15 (50...60 Hz)

U<sub>e</sub> (V) 230

I<sub>e</sub> (A) 3

Direct current: DC13 (6 oper. cycles/min.)

U<sub>e</sub> (V) 24

I<sub>e</sub> (A) 4

#### Quality marks:



EC type examination certificate: IMQ CP 432 DM

UL approval: E131787

CCC approval: 2013010305640211

EAC approval: RU C-IT.A.35.B.00454

#### Compliance with the requirements of:

Machinery Directive 2006/42/EC, EMC Directive 2014/30/EC, RoHS Directive 2011/65/EU.

#### Technical data

##### Housing

Polyamide housing PA 66, self-extinguishing V0 acc. to UL 94

Protection degree acc. to EN 60529:

IP40 (housing), IP20 (terminal strip)

Dimensions:

see page 317, design C

##### General data

SIL level (SIL CL) up to:

SIL CL 3 acc. to EN 62061

Performance Level (PL) up to:

PL e acc. to EN ISO 13849-1

Safety category up to:

category 4 (instantaneous contacts), category 3 (delayed contacts) acc. to EN ISO 13849-1

Safety parameters:

see page 375

Ambient temperature:

-25°C...+55°C

Mechanical endurance:

>10 million operating cycles

Electrical endurance:

>100,000 operating cycles

Pollution degree:

external 3, internal 2

Rated impulse withstand voltage (U<sub>imp</sub>):

4 kV

Rated insulation voltage (U):

250 V

Overtoltage category:

II

##### Supply

Rated supply voltage (U<sub>n</sub>):

24 Vac/dc; 50...60 Hz

120 Vac; 50...60 Hz

230 Vac; 50...60 Hz

Max. DC residual ripple in DC:

10%

Supply voltage tolerance:

±15% of U<sub>n</sub>

Power consumption AC:

< 10 VA

Power consumption DC:

< 5 W

##### Control circuit

Protection against short circuits:

PTC resistance, I<sub>h</sub>=0.5 A

PTC times:

Response time > 100 ms, release time > 3 s

Maximum resistance per input:

≤ 50 Ω

Current per input:

30 mA (typical)

Min. duration of start impulse t<sub>MIN</sub>:

> 200 ms

Response time t<sub>A</sub>:

< 150 ms

Release time t<sub>R1</sub>:

< 25 ms

Release time in absence of power supply t<sub>R</sub>:

< 150 ms

Release time, delayed contacts t<sub>R2</sub>:

see "Code structure"

Simultaneity time t<sub>C</sub>:

unlimited

##### In compliance with standards:

EN 60204-1, EN ISO 13855, EN 1037, EN ISO 12100, EN ISO 13850, EN 60529, EN 61000-6-2, EN 61000-6-3, EN 61326-1, EN 60664-1, EN 60947-1, EN 50581, EN ISO 13849-1, EN ISO 13849-2, EN 62061, UL 508, CSA C22.2 n° 14-95, GB/T14048.5-2017

##### Output circuit

Output contacts:

3 instantaneous NO safety contacts, 2 delayed NO safety contacts.

Contact type:

forcibly guided

Material of the contacts:

gold-plated silver alloy

Maximum switching voltage:

230/240 Vac; 300 Vdc

Max. current per contact:

6 A

Conventional free air thermal current I<sub>th</sub>:

6 A

Max. total current Σ I<sub>th</sub><sup>2</sup>:

72 (instant. contacts), 36 (del. contacts) A<sup>2</sup>

Minimum current:

10 mA

Contact resistance:

≤ 100 mΩ

External protection fuse:

4 A

The number and the load capacity of output contacts can be increased by using expansion modules or contactors. See pages 263-272.

#### Code structure

article options  
**CS AT-10V024-TF1**

Release time, delayed contacts (t<sub>R2</sub>)

- |   |                          |
|---|--------------------------|
| 0 | Fixed time (see TF)      |
| 1 | 0.3 ... 3 s, 0.3 s steps |
| 2 | 1 ... 10 s, 1 s steps    |
| 3 | 3 ... 30 s, 3 s steps    |
| 4 | 30 ... 300 s, 30 s steps |

Release time, delayed contacts (t<sub>R2</sub>)

- |       |                  |
|-------|------------------|
| TF0.5 | 0.5 s fixed time |
| TF1   | 1 s fixed time   |
| TF3   | 3 s fixed time   |
| ...   | .....            |

Supply voltage

- |     |           |
|-----|-----------|
| 024 | 24 Vac/dc |
| 120 | 120 Vac   |
| 230 | 230 Vac   |

Connection type

- |   |                                 |
|---|---------------------------------|
| V | Screw terminals                 |
| M | Connector with screw terminals  |
| X | Connector with spring terminals |

#### Features approved by UL

- |   |   |
|---|---|
| Rated supply voltage (U <sub>n</sub> ): | 24 Vac/dc; 50...60 Hz<br>120 Vac; 50...60 Hz<br>230 Vac; 50...60 Hz |
| Power consumption AC:                   | < 10 VA   |
| Power consumption DC:                   | < 4 W   |
| Electrical ratings:                     | 230/240 Vac<br>6 A general use<br>C300 pilot duty                   |

Notes:

- Use 60 or 75°C copper (Cu) conductor and wire size No. 30-12 AWG, stranded or solid.
- The terminal tightening torque of 5-7 lb in.
- Only for 24 Vac/dc versions: supply from remote Class 2 source or limited voltage limited energy.
- Surrounding air of 55°C.



### Safety module CS AT-1

#### Pin assignment

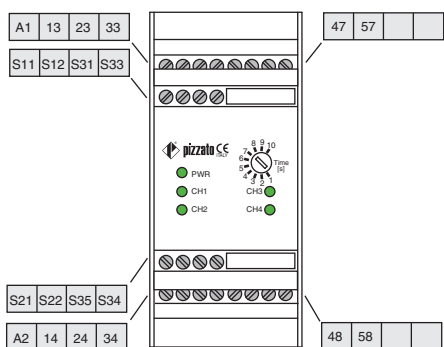

#### Internal block diagram

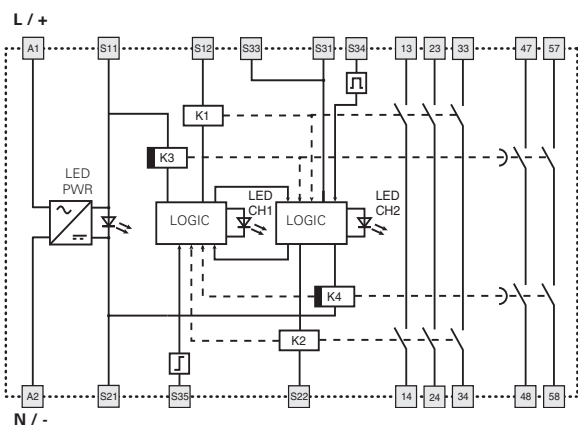

#### Input configuration

##### OSSD semiconductor outputs (e.g. ST, NS, NG series or light barriers)

##### Input configuration with manual start

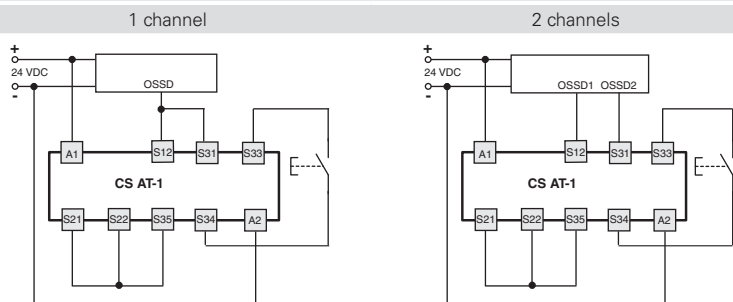

##### Emergency stop circuits

##### Input configuration with manual start

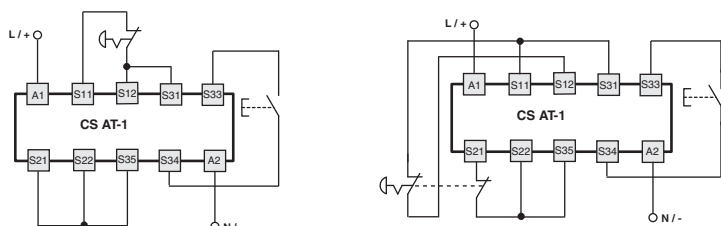

#### Function diagrams

##### Configuration with automatic start

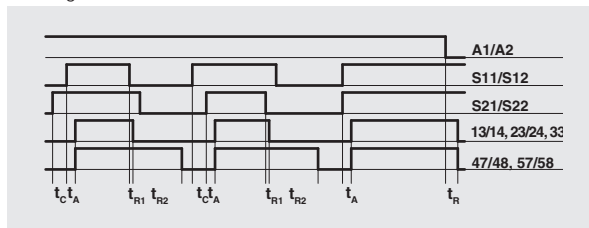

##### Configuration with monitored start

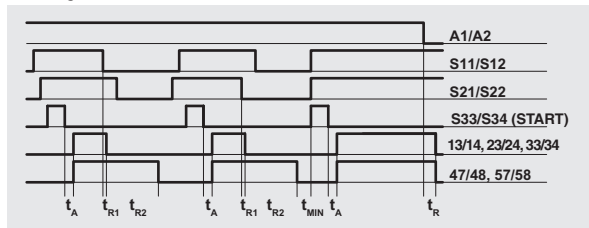

##### Configuration with manual start

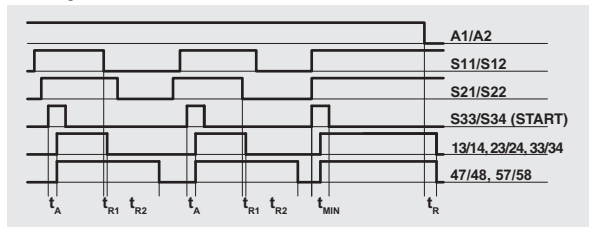

#### Legend:

- $t_{MIN}$ : Min. duration of start impulse
- $t_c$ : simultaneity time
- $t_A$ : response time
- $t_{R1}$ : release time
- $t_r$ : release time in absence of power supply
- $t_{R2}$ : release time, delayed contacts adjustable (see "Code structure")

#### Notes:

The configurations with one channel are obtained taking into consideration the S11/S12 input only. In this case it is necessary to consider time  $t_{R1}$  and  $t_{R2}$  referred to input S11/S12, time  $t_R$  referred to the supply, time  $t_A$  referred to input S11/S12 and to the start, and time  $t_{MIN}$  referred to the start.

#### Automatic start

With regard to the indicated diagrams, bridge the start button between S33 and S34 in order to activate the automatic start module.

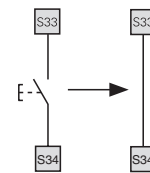

#### Monitored start

With regard to the indicated diagrams, remove the connection between S22 and S35 in order to activate the monitored start module.

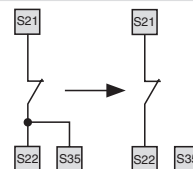

#### Monitoring of movable guards and magnetic safety sensors

The safety module can monitor emergency stop circuits, control circuits for movable guards as well as magnetic safety sensors. Replace the emergency stop contacts with switch contacts or sensor contacts.

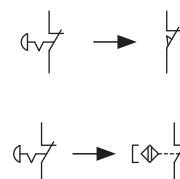

The sensors can only be used in 2-channel configuration.

The diagram does not show the exact position of the terminals in the product



### Module for emergency stop and end position monitoring for movable guards with delayed contacts at the opening of the input channels and magnetic safety sensors

#### Main features

- For safety applications up to SIL CL 3/PL e
- Input with 1 or 2 channels
- Choice between automatic start, manual start or monitored start
- Can be connected to electromechanical contacts or to magnetic safety sensors
- 45 mm housing
- 2 instantaneous NO safety contacts, 1 delayed NO safety contact.
- Supply voltage: 24 Vac/dc

#### Utilization categories

Alternating current: AC15 (50...60 Hz)

U<sub>e</sub> (V) 230

I<sub>e</sub> (A) 3

Direct current: DC13 (6 oper. cycles/min.)

U<sub>e</sub> (V) 24

I<sub>e</sub> (A) 4

#### Quality marks:



EC type examination certificate: IMQ CP 432 DM

UL approval: E131787

CCC approval: 2013010305640211

EAC approval: RU C-IT.AJ35.B.00454

#### Compliance with the requirements of:

Machinery Directive 2006/42/EC, EMC Directive

2014/30/EC, RoHS Directive 2011/65/EU.

## Technical data

### Housing

Polyamide housing PA 66, self-extinguishing V0 acc. to UL 94

Protection degree acc. to EN 60529:

IP40 (housing), IP20 (terminal strip)

Dimensions:

see page 317, design C

### General data

SIL level (SIL CL) up to:

SIL CL 3 acc. to EN 62061

Performance Level (PL) up to:

PL e acc. to EN ISO 13849-1

Safety category up to:

category 4 (instantaneous contacts)

category 3 (delayed contacts)

acc. to EN ISO 13849-1

see page 375

Safety parameters:

Ambient temperature:

-25°C...+55°C

Mechanical endurance:

>10 million operating cycles

Electrical endurance:

>100,000 operating cycles

Pollution degree:

external 3, internal 2

Rated impulse withstand voltage (U<sub>imp</sub>):

4 kV

Rated insulation voltage (U<sub>i</sub>):

250 V

Overvoltage category:

II

### Supply

Rated supply voltage (U<sub>n</sub>):

24 Vac/dc; 50...60 Hz

Max. DC residual ripple in DC:

10%

Supply voltage tolerance:

±15% of U<sub>n</sub>

Power consumption AC:

< 10 VA

Power consumption DC:

< 5 W

### Control circuit

Protection against short circuits:

PTC resistance, I<sub>h</sub>=0.5 A

PTC times:

Response time > 100 ms, release time > 3 s

Maximum resistance per input:

≤ 50 Ω

Current per input:

30 mA (typical)

Min. duration of start impulse t<sub>MIN</sub>:

> 100 ms

Response time t<sub>A</sub>:

< 120 ms

Release time t<sub>R1</sub>:

< 15 ms

Release time in absence of power supply t<sub>R</sub>:

< 150 ms

Release time, delayed contacts t<sub>R2</sub>:

see "Code structure"

Simultaneity time t<sub>c</sub>:

unlimited

### In compliance with standards:

EN 60204-1, EN ISO 13855, EN 1037, EN ISO 12100, EN ISO 13850, EN 60529, EN 61000-6-2, EN 61000-6-3, EN 61326-1, EN 60664-1, EN 60947-1, EN 50581, EN ISO 13849-1, EN ISO 13849-2, EN 62061, UL 508, CSA C22.2 n° 14-95, GB/T14048.5-2017

### Output circuit

Output contacts:

2 instantaneous NO safety contacts,

1 delayed NO safety contact.

Contact type:

forcibly guided

Material of the contacts:

gold-plated silver alloy

Maximum switching voltage:

230/240 Vac; 300 Vdc

Max. current per contact:

6 A

Conventional free air thermal current I<sub>th</sub>:

6 A

Max. total current Σ I<sub>th</sub><sup>2</sup>:

36 A<sup>2</sup>

Minimum current:

10 mA

Contact resistance:

≤ 100 mΩ

External protection fuse:

4 A

The number and the load capacity of output contacts can be increased by using expansion modules or contactors. See pages 263-272.

## Code structure

article options  
**CS AT-30V024-TF1**

#### Release time, delayed contacts (t<sub>R2</sub>)

- |   |                          |
|---|--------------------------|
| 0 | Fixed time (see TF)      |
| 1 | 0.3 ... 3 s, 0.3 s steps |
| 2 | 1 ... 10 s, 1 s steps    |
| 3 | 3 ... 30 s, 3 s steps    |
| 4 | 30 ... 300 s, 30 s steps |

#### Release time, delayed contacts (t<sub>R2</sub>)

- |       |                  |
|-------|------------------|
| TF0.5 | 0.5 s fixed time |
| TF1   | 1 s fixed time   |
| TF3   | 3 s fixed time   |
| ...   | .....            |

#### Supply voltage

- |     |           |
|-----|-----------|
| 024 | 24 Vac/dc |
|-----|-----------|

#### Connection type

- |   |                                 |
|---|---------------------------------|
| V | Screw terminals                 |
| M | Connector with screw terminals  |
| X | Connector with spring terminals |

## Features approved by UL

Rated supply voltage (U <sub>n</sub> ):	24 Vac/dc; 50...60 Hz
Power consumption AC:	< 10 VA
Power consumption DC:	< 4 W
Electrical ratings:	230/240 Vac 6 A general use C300 pilot duty

#### Notes:

- Use 60 or 75°C copper (Cu) conductor and wire size No. 30-12 AWG, stranded or solid.
- The terminal tightening torque of 5-7 lb in.
- Only for 24 Vac/dc versions: supply from remote Class 2 source or limited voltage limited energy.
- Surrounding air of 55°C.



### Safety module CS AT-3

#### Pin assignment

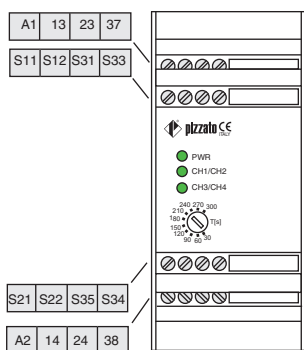

#### Internal block diagram

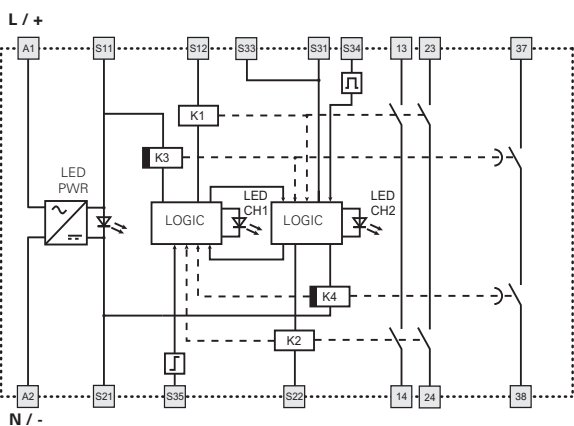

#### Function diagrams

Configuration with automatic start

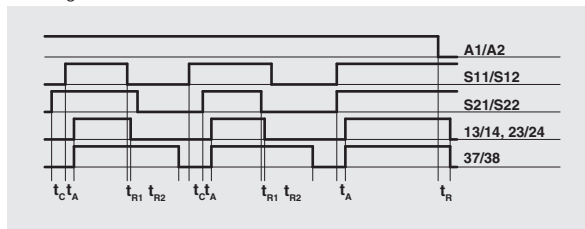

Configuration with monitored start

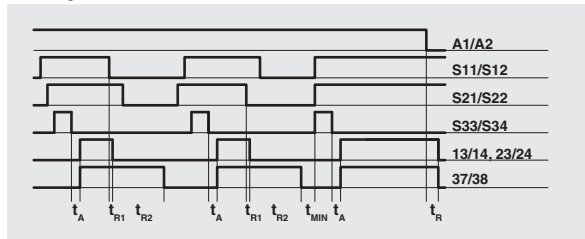

Configuration with manual start

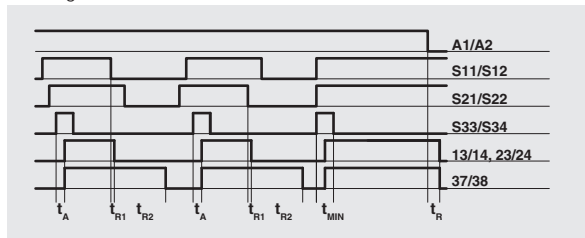

- Legend:
- $t_{MIN}$ : Min. duration of start impulse
  - $t_c$ : simultaneity time
  - $t_A$ : response time
  - $t_{R1}$ : release time
  - $t_{R2}$ : release time in absence of power supply
  - $t_{R2}$ : release time, delayed contacts adjustable (see "Code structure")

Notes:  
The configurations with one channel are obtained taking into consideration the S11/S12 input only. In this case it is necessary to consider times  $t_{R1}$  and  $t_{R2}$  referred to input S11/S12, time  $t_A$  referred to the supply, time  $t_A$  referred to input S11/S12 and to the start, and time  $t_{MIN}$  referred to the start.

#### Input configuration

Emergency stop circuits	
Input configuration with manual start	
1 channel	2 channels

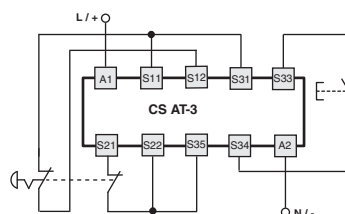
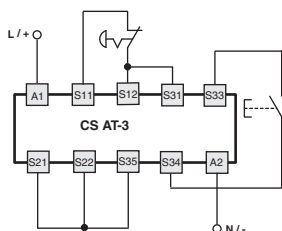

The diagram does not show the exact position of the terminals in the product

#### Automatic start

With regard to the indicated diagrams, bridge the start button between S33 and S34 in order to activate the automatic start module.

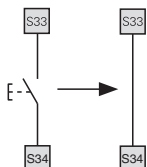

#### Monitored start

With regard to the indicated diagrams, remove the connection between S22 and S35 in order to activate the monitored start module.

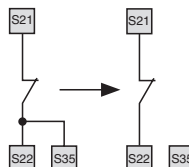

#### Monitoring of movable guards and magnetic safety sensors

The safety module can monitor emergency stop circuits, control circuits for movable guards as well as magnetic safety sensors. Replace the emergency stop contacts with switch contacts or sensor contacts. The sensors can only be used in 2-channel configuration.

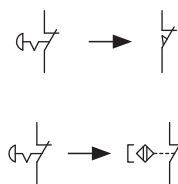

Application examples See page 273