

Main features

- Operating temperature up to +120°C
- Technopolymer housing
- High reliability contacts
- 4 terminal types available
- 15 actuators available
- Versions with positive opening ⊕
- Versions with gold-plated silver contacts

Quality marks:



IMQ approval: CA02.05772
 UL approval: E131787
 EAC approval: RU C-IT.AQ35.B.00454

Installation for safety applications:

Use only microswitches marked with the symbol ⊕ next to the product code. Always connect the safety circuit to the **NC contacts** (normally closed contacts) as required by **EN ISO 14119, paragraph 5.4** for specific interlock applications and **EN ISO 13849-2 tables D3** (well-trying components) and **D.8** (failure exclusions) for safety applications in general. Actuate the switch **at least up to the positive opening travel (CAP)** reported next to the article code. Actuate the switch **at least with the positive opening force (FAP)** reported next to the article code.

⚠ **If not expressly indicated in this chapter, for correct installation and utilization of all articles see the instructions given on pages 223 to 236.**

Technical data

Housing

Housing made of glass fibre reinforced technopolymer, self-extinguishing and shock-proof.
 Protection degree acc. to EN 60529: IP00 (terminals)
 IP40 (electrical contacts)

General data

Ambient temperature: -25°C ... +120°C
 Max. actuation frequency: 3600 operating cycles/hour
 Mechanical endurance: 500,000 operating cycles
 Safety parameter B_{10D}: 1,000,000 for NC contacts
 Tightening torques for installation: see page 190

Cable cross section (flexible copper strands)

MK series: min. 1 x 0.34 mm² (1 x AWG 22)
 max. 2 x 1.5 mm² (2 x AWG 16)

Cable stripping length (x):

MK V••••• articles (screw connection): 7 mm

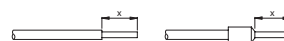

In compliance with standards:

IEC 60947-5-1, EN 60947-5-1, IEC 60529, EN 60529, EN 60947-1, EN 50581, IEC 60947-1.

Compliance with the requirements of:

Low Voltage Directive 2014/35/EU, EMC Directive 2014/30/EU, RoHS Directive 2011/65/EU.

Positive contact opening in conformity with standards:

IEC 60947-5-1, EN 60947-5-1.

Electrical data

Utilization category

Ambient temperature +20°C			Utilization category			
Ambient temperature +20°C	Thermal current (I _{th}):	16 A	Alternating current: AC15 (50 ... 60 Hz)			
	Rated insulation voltage (U):	250 Vac 300 Vdc	Ue (V)	120	250	
	Rated impulse withstand voltage (U _{imp}):	4 kV	Ie (A)	3	5	
	Conditional short circuit current:	1000 A acc. to EN 60947-5-1	Direct current: DC13			
	Protection against short circuits:	type gG fuse 16 A 250 V	Ue (V)	24	125	250
	Pollution degree:	3	Ie (A)	5	0.6	0.3
	Dielectric strength	2000 Vac/min.				
Ambient temperature +120°C	Thermal current (I _{th}):	16 A	Alternating current: AC15 (50 ... 60 Hz)			
	Rated insulation voltage (U):	250 Vac 300 Vdc	Ue (V)	120	250	
	Rated impulse withstand voltage (U _{imp}):	4 kV	Ie (A)	3	2	
	Conditional short circuit current:	1000 A acc. to EN 60947-5-1	Direct current: DC13			
	Protection against short circuits:	type gG fuse 16 A 250 V	Ue (V)	24	125	
	Pollution degree:	3	Ie (A)	2	0.5	
	Dielectric strength	2000 Vac/min.				



Terminal dimensions

All values in the drawings are in mm

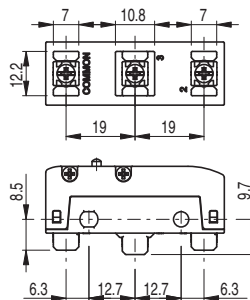

Screw terminals **V** with plate

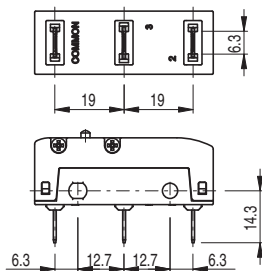

Faston terminals **H**, vertical

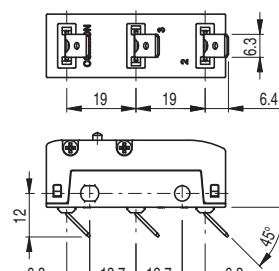

Faston terminals **F**, right angle

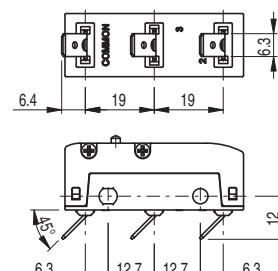

Faston terminals **G**, left angle (upon request)

Note: The vertical faston terminals H can be bent according to specific installation requirements. We recommend to bend the faston with an angle not higher than 45° and to carry out this operation no more than 5 times.

Circuit diagram

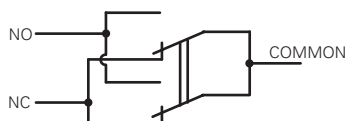

Mobile contact with single interruption and double contacts

With direct actuation and direct actuation at the back (F, D)

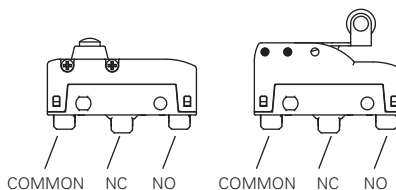

Actuation forces and travels

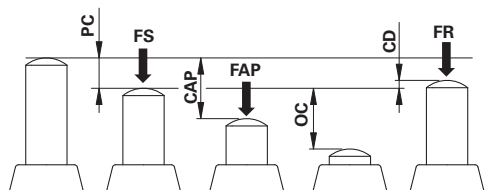

PC pre-travel
CAP positive opening travel
OC over-travel
CD differential travel

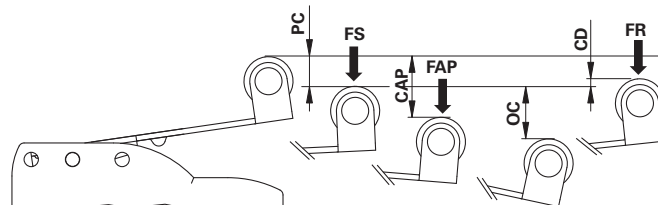

FS trigger force
FR release force
FAP positive opening force

Code structure

Attention! The feasibility of a code number does not mean the effective availability of a product. Please contact our sales office.

article options
MK V11F45-GR16T7

Terminal type	
V	screw with self-lifting plate
H	vertical faston
F	Faston, 45° bend to the right
G	Faston, 45° bend to the left (on request)

Ambient temperature	
T7	-25°C ... +120°C

Rollers	
R16	metal roller Ø 9.5x4 mm (for actuators 40, 42, 45, 59 only)

Contact block	
1	1NO+1NC, snap action, change-over

Contact type	
	silver contacts (standard)
G	silver contacts, 1 µm gold coating

Type of actuation	
D	direct actuation
F	direct actuation at the back

Actuator	
05	low plunger
06	threaded plunger
08	threaded plunger
..

MK series microswitches for high temperatures

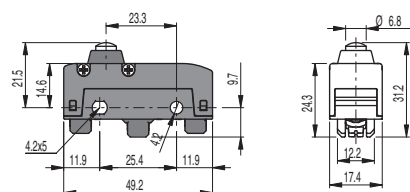

MK V11D05-T7	➔ 1NO+1NC	PC 0.5 mm	FS 4 N
		OC 2 mm	FR 3 N
		CD 0.05 mm	FAP 20 N
		CAP 2.2 mm	

Maximum and minimum speed see page 233 - type 1

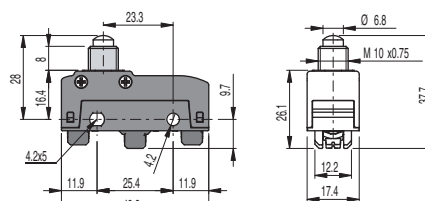

MK V11D06-T7	➔ 1NO+1NC	PC 0.5 mm	FS 4 N
		OC 3 mm	FR 3 N
		CD 0.05 mm	FAP 20 N
		CAP 2.2 mm	

Maximum and minimum speed see page 233 - type 1

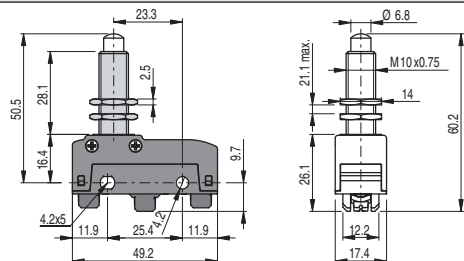

MK V11D08-T7	➔ 1NO+1NC	PC 0.5 mm	FS 4 N
		OC 5.5 mm	FR 3 N
		CD 0.05 mm	FAP 20 N
		CAP 2.2 mm	

Maximum and minimum speed see page 233 - type 1

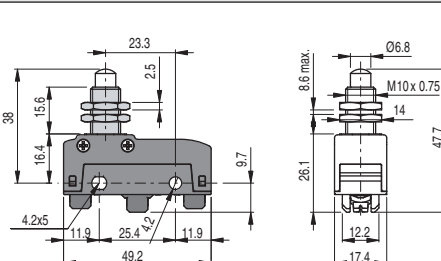

MK V11D09-T7	➔ 1NO+1NC	PC 0.5 mm	FS 4 N
		OC 5.5 mm	FR 3 N
		CD 0.05 mm	FAP 20 N
		CAP 2.2 mm	

Maximum and minimum speed see page 233 - type 1

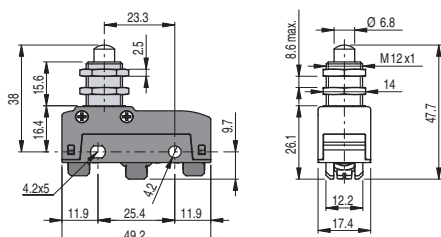

MK V11D10-T7	➔ 1NO+1NC	PC 0.5 mm	FS 4 N
		OC 5.5 mm	FR 3 N
		CD 0.05 mm	FAP 20 N
		CAP 2.2 mm	

Maximum and minimum speed see page 233 - type 1

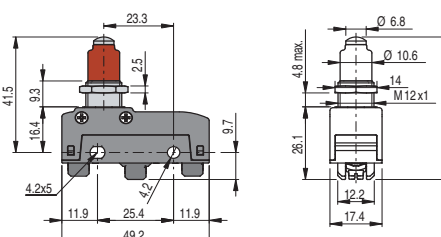

MK V11D12-T7	➔ 1NO+1NC	PC 0.5 mm	FS 4.5 N
		OC 5.5 mm	FR 3 N
		CD 0.05 mm	FAP 20 N
		CAP 2.2 mm	

Maximum and minimum speed see page 233 - type 1

Mounting only through threaded fitting

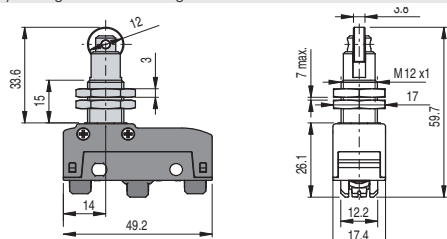

MK V11D15-T7	➔ 1NO+1NC	PC 0.5 mm	FS 4 N
		OC 5.5 mm	FR 3 N
		CD 0.05 mm	FAP 20 N
		CAP 2.2 mm	

Maximum and minimum speed see page 233 - type 2

Mounting only through threaded fitting

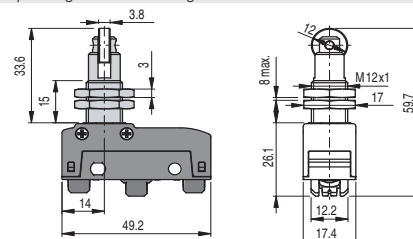

MK V11D17-T7	➔ 1NO+1NC	PC 0.5 mm	FS 4 N
		OC 5.5 mm	FR 3 N
		CD 0.05 mm	FAP 20 N
		CAP 2.2 mm	

Maximum and minimum speed see page 233 - type 2

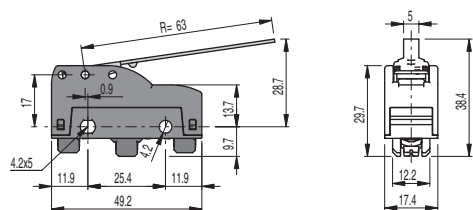

MK V11D30-T7	1NO+1NC	PC 11.5 mm	FS 0.65 N
		OC 7.6 mm	FR 0.5 N
		CD 1.1 mm	

Maximum and minimum speed see page 233 - type 3

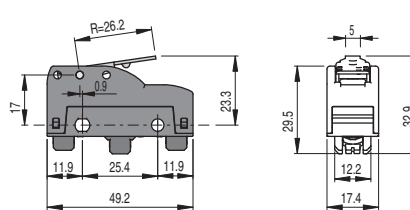

MK V11D31-T7	1NO+1NC	PC 4.6 mm	FS 1.66 N
		OC 3.8 mm	FR 1.32 N
		CD 0.4 mm	

Maximum and minimum speed see page 233 - type 3



MK V11D32-T7 1NO+1NC PC 9.1 mm FS 0.76 N OC 7.1 mm FR 0.58 N CD 0.9 mm	MK V11F40-R16T7 1NO+1NC PC 2.1 mm FS 0.85 N OC 8.3 mm FR 0.65 N CD 0.25 mm
Maximum and minimum speed see page 233 - type 3	
Maximum and minimum speed see page 233 - type 8	
MK V11F42-R16T7 → 1NO+1NC PC 1.8 mm FS 1 N OC 6.7 mm FR 0.7 N CD 0.2 mm FAP 4.9 N CAP 9 mm	MK V11F45-R16T7 → 1NO+1NC PC 1.1 mm FS 1.3 N OC 4.9 mm FR 0.9 N CD 0.1 mm FAP 6.9 N CAP 6.3 mm
Maximum and minimum speed see page 233 - type 8	
Maximum and minimum speed see page 233 - type 8	
MK V11F59-R16T7 → 1NO+1NC PC 0.8 mm FS 1.7 N OC 4.5 mm FR 1.3 N CD 0.08 mm FAP 8.9 N CAP 4.9 mm	
Maximum and minimum speed see page 233 - type 8	

All values in the drawings are in mm

Tightening torques

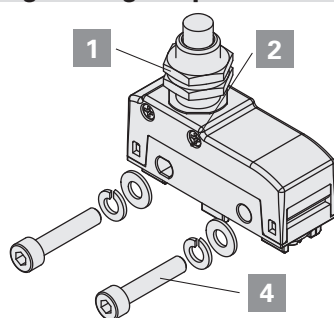

- 1 Head nuts
- 2 Head screws
- 3 Terminal screws
- 4 M4 fixing screws, body (insert a washer and a spring washer)

Attention: a tightening torque higher than 1.2 Nm can cause the breaking of the microswitch.

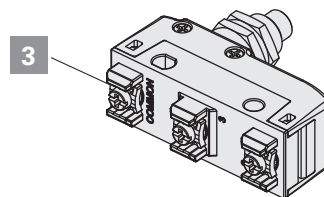

- 2 ... 3 Nm
0.3 ... 0.4 Nm
0.6 ... 0.8 Nm
0.8 ... 1.2 Nm

Accessories

Packs of 10 pcs.

Article VF AC83	Description Hex threaded nut for microswitches with actuators D06, D08, D09

Article VF AC72	Description Hex threaded nut for microswitches with actuators D10, D12, D13

Article AC 35	Description Hex threaded nut, notched, for microswitches with actuators D15, D16