

Selection diagram

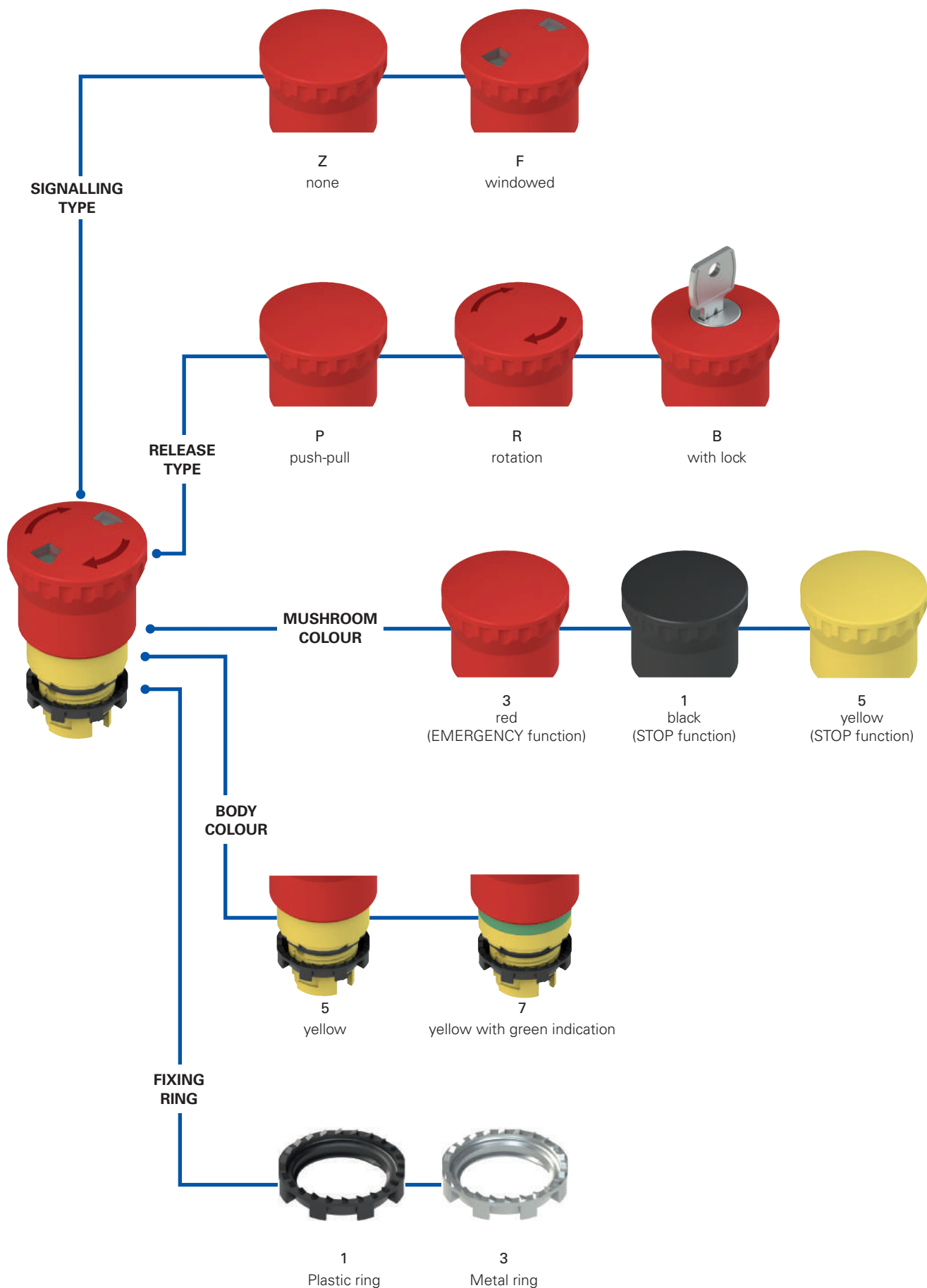

Code structure **Attention!** The feasibility of a code number does not mean the effective availability of a product. Please contact our sales office.

article
options
E2 1PERZ4531-T6

Fixing ring and shaped ring	
1	Plastic ring (standard)
2	Plastic fixing ring and shaped ring
3	Metal ring
4	Metal fixing ring and shaped ring

Release type	
P	push-pull
R	rotary release
B	key release with key 333 (standard) (not available in the windowed version)
C	key release with key 335 (not available in the windowed version)
D	key release with key 336 (not available in the windowed version)
...
M	key release with key 455 (not available in the windowed version)

Other key codes on request.

Signalling type	
Z	none
F	windowed

Ambient temperature	
	-25°C ... +80°C (standard)
T6	-40°C ... +80°C

Actuator type	
1	for 3-slot base
4	for 4-slot base

Mushroom button colour	
1	black (not available with windowed signalling)
3	red (standard)
5	yellow (not available with key release and with windowed signalling)

Body colour	
5	yellow (standard)
7	yellow with green indication

Mushroom diameter	
4	Ø 40 mm mushroom

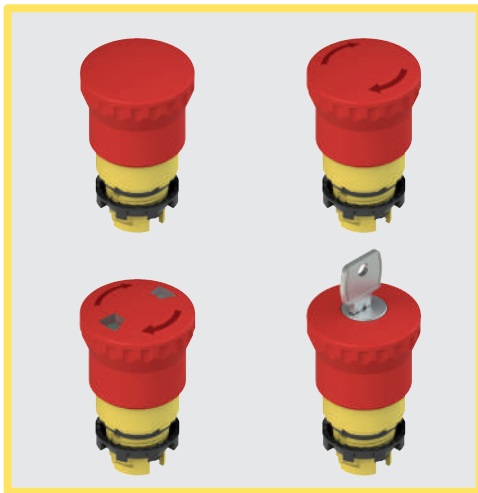

Main features

- Protection degrees IP67 and IP69K
- 3 different release modes
- Windowed version
- -40°C versions

Quality marks:



IMQ approval: CA02.04805
 UL approval: E131787
 EAC approval: RU C-IT.YT03.B.00035/19

Technical data

General data

Protection degree:	IP67 acc. to EN 60529 IP69K acc. to ISO 20653
Ambient temperature:	-25°C ... +80°C (standard) -40°C ... +80°C (T6 option)
Safety parameter B_{10D} :	600,000
Mechanical endurance:	300,000 operating cycles
Max. actuation frequency:	3600 operating cycles/hour
Actuation travel:	4 mm (NO contact), 4 mm (NC contact)
Actuating force:	25 N
Actuating force at limit of travel:	Push-pull 18.5 N (without contacts) Rotary release, 35 N (without contacts)
Maximum travel:	9 mm
Tightening torque of the fixing ring:	2 ... 2.5 Nm
Utilization requirements:	see page 149

In compliance with standards:

IEC 60947-1, IEC 60947-5-1, IEC 60947-5-5, IEC 60204-1, EN 60947-1, EN 60947-5-1, EN 60947-5-5, EN 60204-1, EN IEC 63000, EN ISO 13850, UL 508, CSA 22-2 N°14

⚠ Installation for safety applications:

Use only contact blocks marked with the symbol . The safety circuit must always be connected to **NC contacts** (normally closed contacts: .1-.2).

Compliance with the requirements of:

Machinery Directive 2006/42/EC, RoHS Directive 2011/65/EU.

Positive contact opening in conformity with standards:

IEC 60947-5-1, EN 60947-5-1.

Features approved by UL

For Use on a Flat Surface of a Type 1, 4X, 12 and 13
 Tightening torque 2.0 Nm

General data

Visual signalling



The versions of the emergency stop buttons with pull or rotary release can also visually signal the status with a mechanical indicator. The signalling windows change from green to red to signal the change of status of the button, namely from idle to actuated respectively.

Luminous disc



The luminous disc can also be used in all situations when it is necessary to highlight the emergency button on the machine compared to the other devices, or where there are more mushrooms and it is necessary to know which one has been pressed. Provided with high luminosity, it is available in the versions with continuous or blinking light. Protected with protection degree IP67, it can be customised with writings or symbols upon request. For details see page 139.

Self-monitored contact

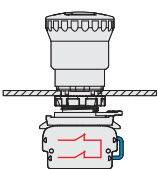

Specially designed for emergency mushroom buttons, the self-monitored contact makes it possible to reach a high level of self-control. Possible anomalies, such as the detachment from the emergency mushroom button, are immediately signalled by the opening of the safety circuit. This makes immediately evident failures that will be otherwise difficult to detect. Indeed,

the detachment of a normal NC contact from the mushroom allows the machine to continue to function and makes the emergency stop unusable. For details see page 91.

Protection degrees IP67 and IP69K

IP69K
IP67

These devices are designed to be used in the toughest environmental conditions and they pass the IP67 immersion test acc. to EN 60529. They can therefore be used in all environments where maximum protection degree of the housing is required. Due to their special design, these devices are suitable for use in equipment subjected to cleaning with high pressure hot water jets. These devices meet the IP69K test requirements according to ISO 20653 (water jets with 100 bar and 80°C).

Shaped ring

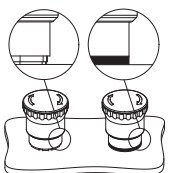

The shaped ring can be used when no label holder or other devices are applied; it prevents dirt and other residues from settling between the button and the panel or housing.

This turns out to be particularly useful in sectors where high standards of cleanness and hygiene are required.

Extended temperature range

-40°C

These devices are also available in a special version suitable for an ambient operating temperature range from -40°C up to +80°C.

They can therefore be used for applications in cold stores, sterilisers and other equipment operated in very low-temperature environments. The special materials used to produce these versions retain their characteristics even under these conditions, thereby expanding the installation possibilities.

Selection table for emergency stop buttons

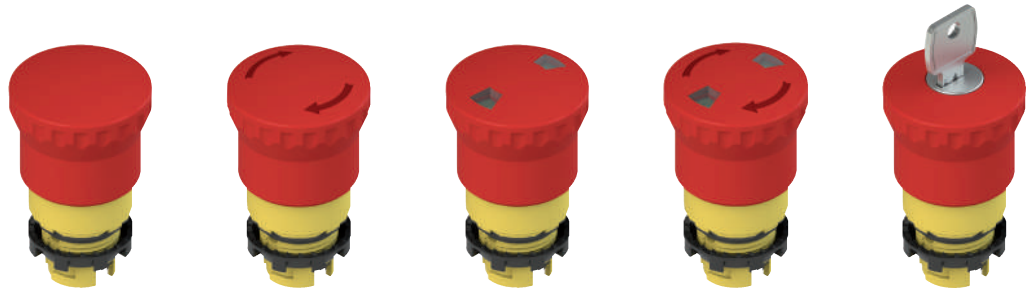





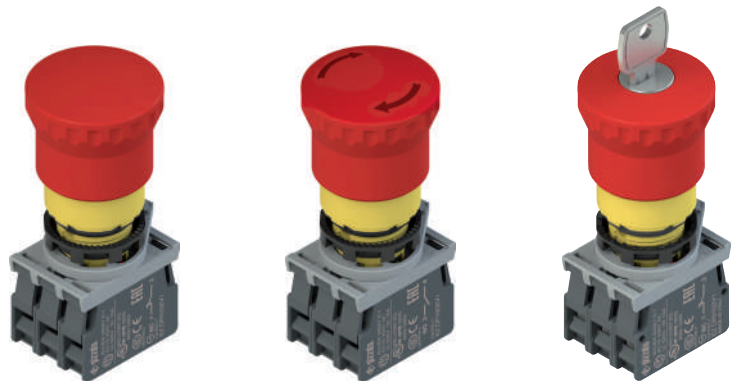

Body colour and marking	Actuator colour	Push-pull	Rotary release	Windowed push-pull	Windowed rotary release	Key release Key coding 333
yellow	red	E2 1PEPZ4531	E2 1PERZ4531	E2 1PEPF4531	E2 1PERF4531	E2 1PEBZ4531
yellow with green indication	red	E2 1PEPZ4731	E2 1PERZ4731	E2 1PEPF4731	E2 1PERF4731	E2 1PEBZ4731
yellow	black	E2 1PEPZ4511	E2 1PERZ4511	-	-	E2 1PEBZ4511
yellow	yellow	E2 1PEPZ4551	E2 1PERZ4551	-	-	-

Attention! For safety applications, only use red mushrooms, black and yellow mushrooms can only be used for stop functions.

Complete units with emergency stop buttons



Body colour and marking	Actuator colour	Contacts			Push-pull	Rotary release	Key release Key coding 333
		pos. 2	pos. 3	pos. 1			
yellow	red	-	1NC 	-	E2 AC-DXBC1005 E2 1PEPZ4531 + E2 1BAC11 + E2 CP01G2V1	E2 AC-DXBC1006 E2 1PERZ4531 + E2 1BAC11 + E2 CP01G2V1	E2 AC-DXBC1007 E2 1PEBZ4531 + E2 1BAC11 + E2 CP01G2V1
yellow	red	-	1NC  SELF-MONITORED	-	E2 AC-DXBC1022 E2 1PEPZ4531 + E2 1BAC11 + E2 CP01S2V1	E2 AC-DXBC1023 E2 1PERZ4531 + E2 1BAC11 + E2 CP01S2V1	E2 AC-DXBC1024 E2 1PEBZ4531 + E2 1BAC11 + E2 CP01S2V1
yellow	red	1NC 	-	1NC 	E2 AC-DXBC1010 E2 1PEPZ4531 + E2 1BAC11 + E2 CP01G2V1 + E2 CP01G2V1	E2 AC-DXBC1002 E2 1PERZ4531 + E2 1BAC11 + E2 CP01G2V1 + E2 CP01G2V1	E2 AC-DXBC1011 E2 1PEBZ4531 + E2 1BAC11 + E2 CP01G2V1 + E2 CP01G2V1
yellow	red	1NC 	1NC 	1NO	E2 AC-DXBC1012 E2 1PEPZ4531 + E2 1BAC11 + E2 CP01G2V1 + E2 CP01G2V1 + E2 CP10G2V1	E2 AC-DXBC1000 E2 1PERZ4531 + E2 1BAC11 + E2 CP01G2V1 + E2 CP01G2V1 + E2 CP10G2V1	E2 AC-DXBC1013 E2 1PEBZ4531 + E2 1BAC11 + E2 CP01G2V1 + E2 CP01G2V1 + E2 CP10G2V1

Other combinations on request.
 → For contact block features see page 85.

Locking keys

Article	Description
VE KE1A00-PY333	Locking key
	Order only if further keys besides the supplied one are needed. Key with key coding 333. Other codes on request.

Dimensions

All values in the drawings are in mm

Emergency stop button

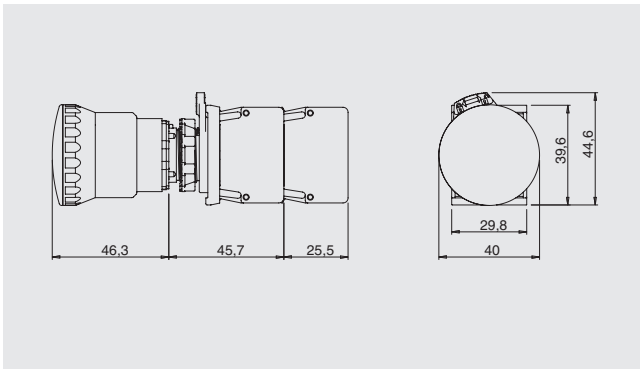

Emergency stop button with key release

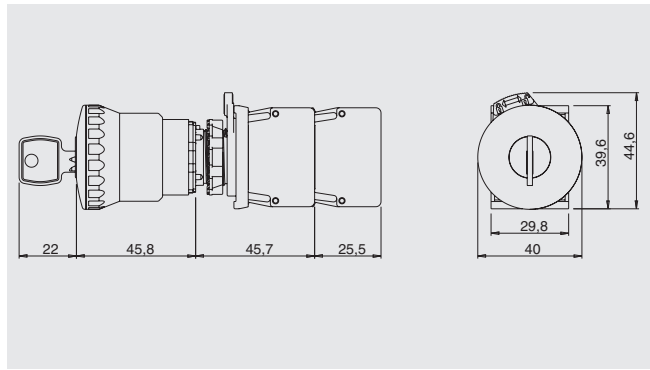

→ The 2D and 3D files are available at www.pizzato.com

Maximum number of contact blocks

3-slot mounting adapter

Emergency stop buttons E2 •PE•••••1

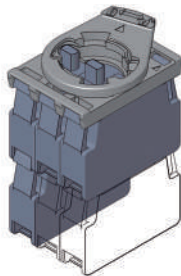

maximum number:
4 contact blocks
2 levels

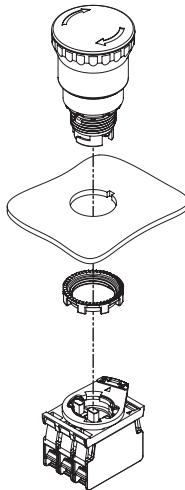

4-slot mounting adapter

Emergency stop buttons E2 •PE•••••4

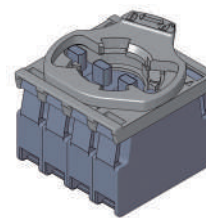

maximum number:
4 contact blocks
1 level

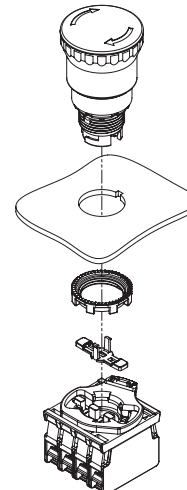

The mounting of the actuator for 4-slot base must be carried out after fixing the button.

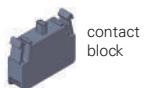

Actuator for 4-slot base Packs of **10 pcs.**

Article	Description
VE AS1218	Closed long actuator for 4-slot mounting adapter. It must be installed after fixing the button to the wall. For E2 •PE•••••4 buttons.

Accessories
 → More ACCESSORIES on page 143

Minimum distances for installation

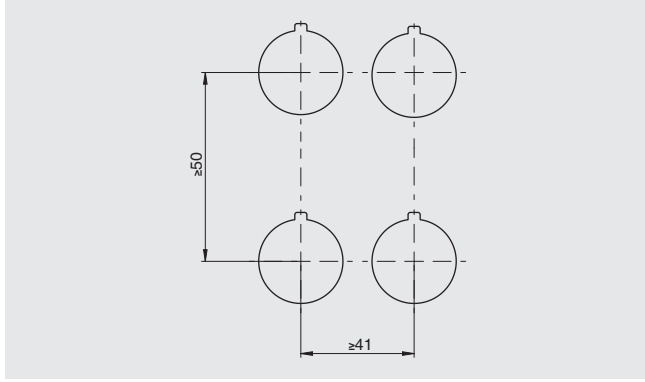

Labels with shaped hole Packs of **5 pcs.**

Suitable for devices E2 •PE•••••.
 In compliance with EN ISO 13850.
 Can be turned in 90° steps.
 Inscriptions in other languages available on request.

It does not alter the IP67 / IP69K protection degree of the associated device.

Article	Description
 VE TF32A5700	Label with shaped hole, Ø 60 mm yellow disc, no inscription, acc. to ISO 13850
 VE TF32D5700	Label with shaped hole, Ø 90 mm yellow disc, no inscription, acc. to ISO 13850
 VE TF32A5113	Label with shaped hole, Ø 60 mm yellow disc, inscription:  , acc. to ISO 13850
 VE TF32D5113	Label with shaped hole, Ø 90 mm yellow disc, inscription:  , acc. to ISO 13850
 VE TF32A5101	Label with shaped hole, Ø 60 mm yellow disc, inscription: STOP  EMERGENZA 
 VE TF32D5101	Label with shaped hole, Ø 90 mm yellow disc, inscription: STOP  EMERGENZA 
 VE TF32A5102	Label with shaped hole, Ø 60 mm yellow disc, inscription: EMERGENCY  STOP 
 VE TF32D5102	Label with shaped hole, Ø 90 mm yellow disc, inscription: EMERGENCY  STOP 
 VE TF32A5109	Label with shaped hole, Ø 60 mm yellow disc, inscription: STOP  STOP  STOP  STOP 
 VE TF32D5109	Label with shaped hole, Ø 90 mm yellow disc, inscription: STOP  STOP  STOP  STOP 
 VE TF32A5120	Label with shaped hole, Ø 60 mm yellow disc, inscription: STOP EMERGENZA  ARRET D'URGENCE  NOT AUS  EMERGENCY STOP 
 VE TF32D5120	Label with shaped hole, Ø 90 mm yellow disc, inscription: STOP EMERGENZA  ARRET D'URGENCE  NOT AUS  EMERGENCY STOP 
 VE TF32G5700	Label with shaped hole, yellow, 30x60 mm rectangular, no engraving, acc. to ISO 13850
 VETF32G5121	Label with shaped hole, yellow, 30x60 mm rectangular, engraving:   , acc. to ISO 13850
 VE TF32G5103	Label with shaped hole, yellow, 30x60 mm rectangular, engraving: STOP 
 VE TF32G5110	Label with shaped hole, yellow, 30x60 mm rectangular, engraving: STOP 

Luminous disc

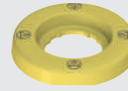
	Yellow luminous disc, Ø 60 mm. Data at page 139
---	--