

Module for emergency stops, end position monitoring for movable guards, OSSD semiconductor outputs and magnetic safety sensors

Main features

- For safety applications up to SIL CL 3/PL e
- Input with 1 or 2 channels
- Choice between automatic start, manual start or monitored start
- Can be connected to OSSD semiconductor outputs, to electromechanical contacts or to magnetic safety sensors
- Reduced housing width of 22.5 mm
- Output contacts:
2 NO safety contacts,
1 NC auxiliary contact
- Supply voltage:
10 ... 30 Vdc, 24 Vac/dc, 120 Vac, 230 Vac

Utilization categories

Alternating current: AC15 (50...60 Hz)

U_e (V) 230

I_e (A) 3

Direct current: DC13 (6 oper. cycles/min.)

U_e (V) 24

I_e (A) 4

Quality marks:



EC type examination certificate: IMQ CP 432 DM

UL approval: E131787

CCC approval: 2020970305002290

EAC approval: RU C-IT.YT03.B.00035/19

Compliance with the requirements of:

Machinery Directive 2006/42/EC,

EMC Directive 2014/30/EC,

RoHS Directive 2011/65/EU.

Technical data

Housing

Polyamide housing PA 66, self-extinguishing V0 acc. to UL 94

Protection degree acc. to EN 60529:

IP40 (housing), IP20 (terminal strip)

Dimensions:

see page 355, design A

General data

SIL level (SIL CL) up to:

SIL CL 3 acc. to EN 62061

Performance Level (PL) up to:

PL e acc. to EN ISO 13849-1

Safety category up to:

cat. 4 acc. to EN ISO 13849-1

Safety parameters:

see page 417

Ambient temperature:

-25°C...+55°C

Mechanical endurance:

>10 million operating cycles

Electrical endurance:

>100,000 operating cycles

Pollution degree:

external 3, internal 2

Rated impulse withstand voltage (U_{imp}):

4 kV

Rated insulation voltage (U_i):

250 V

Overvoltage category:

II

Supply

Rated supply voltage (U_n):

10 ... 30 Vdc
24 Vac/dc; 50...60 Hz
120 Vac; 50...60 Hz
230 Vac; 50...60 Hz

Max. DC residual ripple in DC:

10%

Supply voltage tolerance:

±15% of U_n

Power consumption AC:

< 5 VA

Power consumption DC:

< 2 W

Control circuit

Protection against short circuits:

PTC resistance, I_h=0.5 A

PTC times:

response time > 100 ms, release time > 3 s

Maximum resistance per input:

≤ 50 Ω

Current per input:

30 mA (typical)

Min. duration of start impulse t_{MIN}:

> 100 ms, > 50 ms (E02)

Response time t_A:

< 50 ms, < 150 ms (E02)

Release time t_{R1}:

< 20 ms

Release time in absence of power supply t_{R2}:

< 70 ms, < 100 ms (E02)

Simultaneity time t_c:

unlimited

In compliance with standards:

EN 60204-1, EN ISO 13855, EN ISO 14118, EN ISO 12100, EN ISO 13850, EN 60529, EN 61000-6-2, EN 61000-6-3, EN 61326-1, EN 60664-1, EN 60947-1, EN IEC 63000, EN ISO 13849-1, EN ISO 13849-2, EN 62061, UL 508, CSA C22.2 n° 14-95, GB/T14048.5

Output circuit

Output contacts:

2 NO safety contacts,
1 NC auxiliary contact

Contact type:

forcibly guided

Material of the contacts:

gold-plated silver alloy

Maximum switching voltage:

230/240 Vac; 300 Vdc

Max. current per contact:

6 A

Conventional free air thermal current I_{th}:

6 A

Max. total current Σ I_{th}²:

72 A²

Minimum current:

10 mA

Contact resistance:

≤ 100 mΩ

External protection fuse:

4 A

The number and the load capacity of output contacts can be increased by using expansion modules or contactors. See pages 295-304.

Code structure

CS AR-01V024

Connection type	
V	Screw terminals
M	Connector with screw terminals
X	Connector with spring terminals

Supply voltage	
024	24 Vac/dc
120	120 Vac
230	230 Vac
E02	10 ... 30 Vdc

Features approved by UL

Rated supply voltage (U _n):	24 Vac/dc; 50...60 Hz 120 Vac; 50...60 Hz 230 Vac; 50...60 Hz
Power consumption AC:	< 5 VA
Power consumption DC:	< 4 W
Electrical ratings:	230/240 Vac 6 A general use C300 pilot duty

Notes:

- Use 60 or 75°C copper (Cu) conductor and wire size No. 30-12 AWG, stranded or solid.
- The terminal tightening torque of 5-7 lb in.
- Only for 24 Vac/dc versions: supply from remote Class 2 source or limited voltage limited energy.



Safety module CS AR-01

Pin assignment

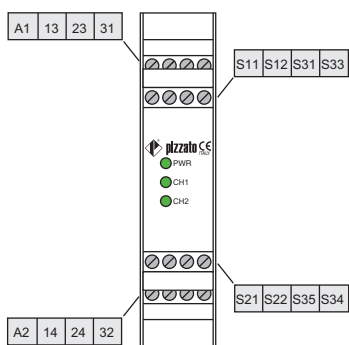

Internal block diagram

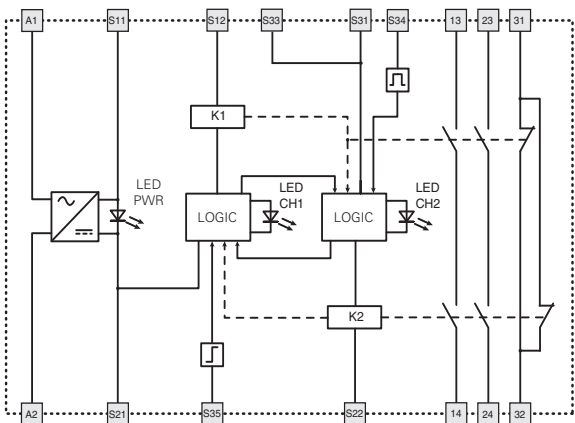

Input configuration

OSSD semiconductor outputs (e.g. ST, NS, NG series or light barriers)

Input configuration with manual start

1 channel

2 channels

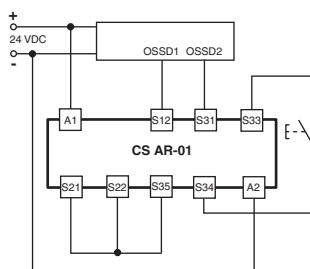
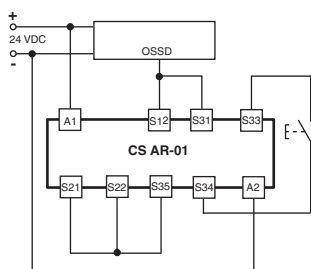

Emergency stop circuits

Input configuration with manual start

1 channel

2 channels

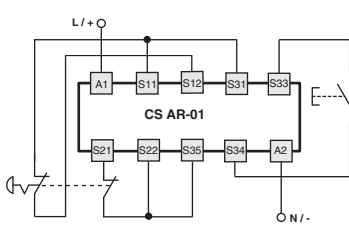
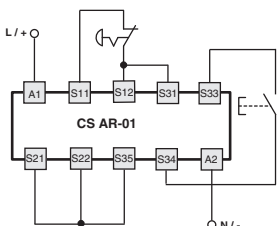

The diagram does not show the exact position of the terminals in the product

Function diagrams

Configuration with automatic start

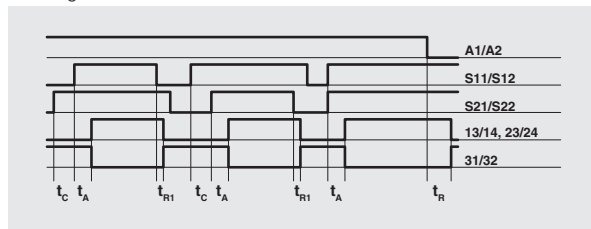

Configuration with monitored start

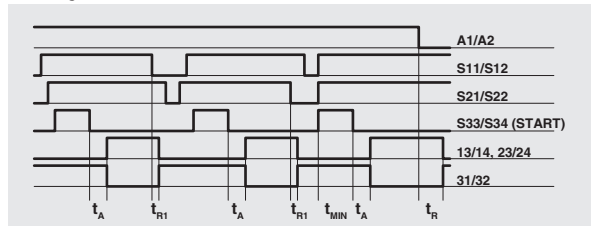

Configuration with manual start

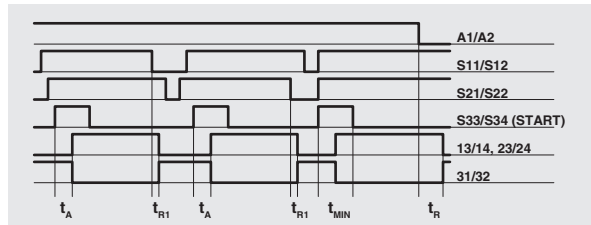

Legend:

- t_{MIN} : Min. duration of start impulse
- t_C : simultaneity time
- t_A : response time
- t_{R1} : release time
- t_R : release time in absence of power supply

Notes:

The configurations with one channel are obtained taking into consideration the S11/S12 input only. In this case it is necessary to consider time t_{R1} referred to input S11/S12, time t_R referred to the supply, time t_A referred to input S11/S12 and to the start, and time t_{MIN} referred to the start.

Automatic start

With regard to the indicated diagrams, bridge the start button between S33 and S34 in order to activate the automatic start module.

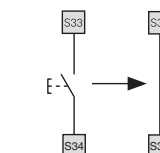

Monitored start

With regard to the indicated diagrams, remove the connection between the S22 and S35 terminals in order to activate the monitored start module.

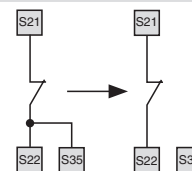

Monitoring of movable guards and magnetic safety sensors

The safety module can monitor emergency stop circuits, control circuits for movable guards as well as magnetic safety sensors. Replace the emergency stop contacts with switch contacts or sensor contacts.

The sensors can only be used in 2-channel configuration.

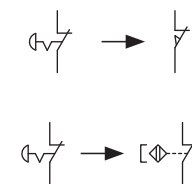

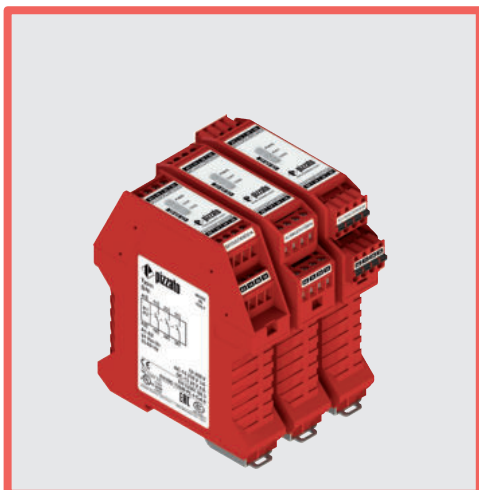

Module for emergency stops, end position monitoring for movable guards, OSSD semiconductor outputs and magnetic safety sensors

Main features

- For safety applications up to SIL CL 3/PL e
- Input with 1 or 2 channels
- Choice between automatic start, manual start or monitored start
- Can be connected to OSSD semiconductor outputs, to electromechanical contacts or to magnetic safety sensors
- Reduced housing width of 22.5 mm
- Output contacts:
3 NO safety contacts
- Supply voltage:
10 ... 30 Vdc, 24 Vac/dc, 120 Vac, 230 Vac

Utilization categories

Alternating current: AC15 (50...60 Hz)

U_e (V) 230

I_e (A) 3

Direct current: DC13 (6 oper. cycles/min.)

U_e (V) 24

I_e (A) 4

Quality marks:



EC type examination certificate: IMQ CP 432 DM

UL approval: E131787

CCC approval: 2020970305002290

EAC approval: RU C-IT.YT03.B.00035/19

Compliance with the requirements of:

Machinery Directive 2006/42/EC,

EMC Directive 2014/30/EC,

RoHS Directive 2011/65/EU.

Technical data

Housing

Polyamide housing PA 66, self-extinguishing V0 acc. to UL 94

Protection degree acc. to EN 60529:

IP40 (housing), IP20 (terminal strip)

Dimensions:

see page 355, design A

General data

SIL level (SIL CL) up to:

SIL CL 3 acc. to EN 62061

Performance Level (PL) up to:

PL e acc. to EN ISO 13849-1

Safety category up to:

cat. 4 acc. to EN ISO 13849-1

Safety parameters:

see page 417

Ambient temperature:

-25°C...+55°C

Mechanical endurance:

>10 million operating cycles

Electrical endurance:

>100,000 operating cycles

Pollution degree:

external 3, internal 2

Rated impulse withstand voltage (U_{imp}):

4 kV

Rated insulation voltage (U_i):

250 V

Overvoltage category:

II

Supply

Rated supply voltage (U_n):

10 ... 30 Vdc

24 Vac/dc; 50...60 Hz

120 Vac; 50...60 Hz

230 Vac; 50...60 Hz

Max. DC residual ripple in DC:

10%

Supply voltage tolerance:

±15% of U_n

Power consumption AC:

< 5 VA

Power consumption DC:

< 2 W

Control circuit

Protection against short circuits:

PTC resistance, I_h=0.5 A

PTC times:

response time > 100 ms, release time > 3 s

Maximum resistance per input:

≤ 50 Ω

Current per input:

< 30 mA

Min. duration of start impulse t_{MIN}:

> 100 ms

Response time t_A:

< 50 ms

Release time t_{R1}:

< 20 ms

Release time in absence of power supply t_R:

< 70 ms

Simultaneity time t_C:

unlimited

In compliance with standards:

EN 60204-1, EN ISO 13855, EN ISO 14118, EN ISO 12100, EN ISO 13850, EN 60529, EN 61000-6-2, EN 61000-6-3, EN 61326-1, EN 60664-1, EN 60947-1, EN IEC 63000, EN ISO 13849-1, EN ISO 13849-2, EN 62061, UL 508, CSA C22.2 n° 14-95, GB/T14048.5

Output circuit

Output contacts:

3 NO safety contacts,

Contact type:

forcibly guided

Material of the contacts:

gold-plated silver alloy

Maximum switching voltage:

230/240 Vac; 300 Vdc

Max. current per contact:

6 A

Conventional free air thermal current I_{th}:

6 A

Max. total current Σ I_{th}²:

72 A²

Minimum current:

10 mA

Contact resistance:

≤ 100 mΩ

External protection fuse:

4 A

The number and the load capacity of output contacts can be increased by using expansion modules or contactors. See pages 295-304.

Code structure

CS AR-02V024

Connection type	
V	Screw terminals
M	Connector with screw terminals
X	Connector with spring terminals

Supply voltage	
024	24 Vac/dc
120	120 Vac
230	230 Vac
E02	10 ... 30 Vdc

Features approved by UL

Rated supply voltage (U _n):	24 Vac/dc; 50...60 Hz 120 Vac; 50...60 Hz 230 Vac; 50...60 Hz
Power consumption AC:	< 5 VA
Power consumption DC:	< 4 W
Electrical ratings:	230/240 Vac 6 A general use C300 pilot duty

Notes:

- Use 60 or 75°C copper (Cu) conductor and wire size No. 30-12 AWG, stranded or solid.
- The terminal tightening torque of 5-7 lb in.
- Only for 24 Vac/dc versions: supply from remote Class 2 source or limited voltage limited energy.



Safety module CS AR-02

Pin assignment

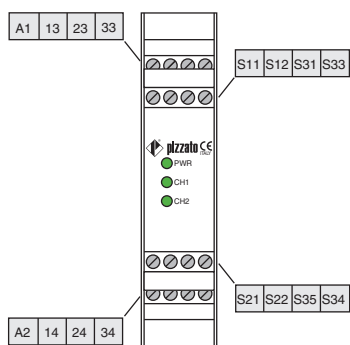

Internal block diagram

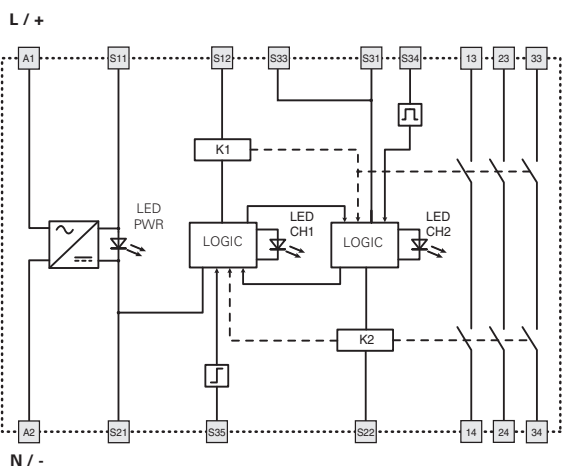

Function diagrams

Configuration with automatic start

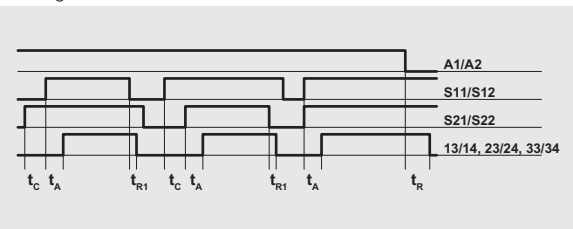

Configuration with monitored start

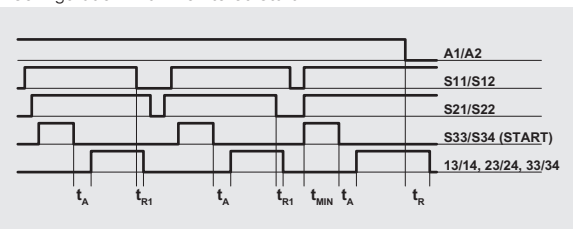

Configuration with manual start

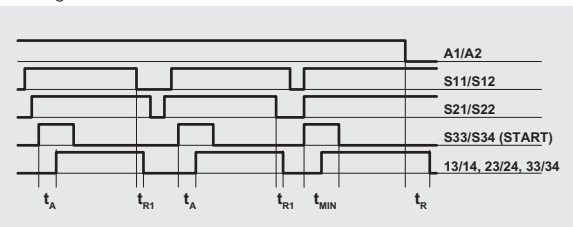

Legend: t_MIN: Min. duration of start impulse; t_c: simultaneity time; t_A: response time; t_R1: release time; t_r: release time in absence of power supply

Notes: The configurations with one channel are obtained taking into consideration the S11/S12 input only. In this case it is necessary to consider time t_R1 referred to input S11/S12, time t_R referred to the supply, time t_A referred to input S11/S12 and to the start, and time t_MIN referred to the start.

Input configuration

OSSD semiconductor outputs (e.g. ST, NS, NG series or light barriers)

Input configuration with manual start

1 channel 2 channels

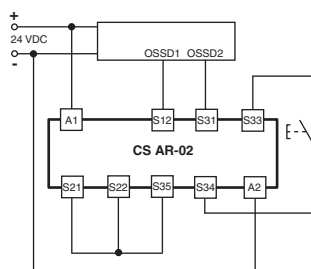
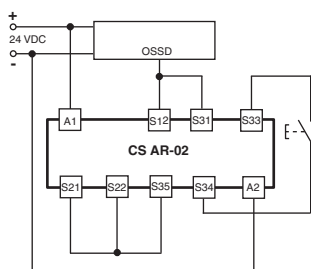

Emergency stop circuits

Input configuration with manual start

1 channel 2 channels

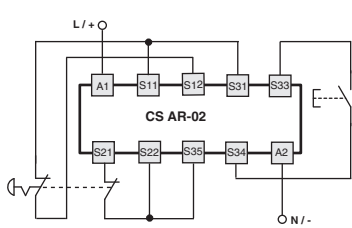
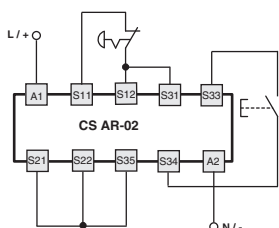

The diagram does not show the exact position of the terminals in the product

Automatic start

With regard to the indicated diagrams, bridge the start button between S33 and S34 in order to activate the automatic start module.

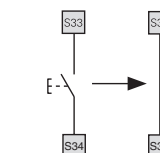

Monitored start

With regard to the indicated diagrams, remove the connection between the S22 and S35 terminals in order to activate the monitored start module.

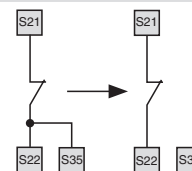

Monitoring of movable guards and magnetic safety sensors

The safety module can monitor emergency stop circuits, control circuits for movable guards as well as magnetic safety sensors. Replace the emergency stop contacts with switch contacts or sensor contacts. The sensors can only be used in 2-channel configuration.

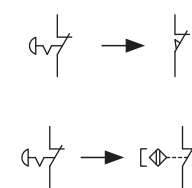

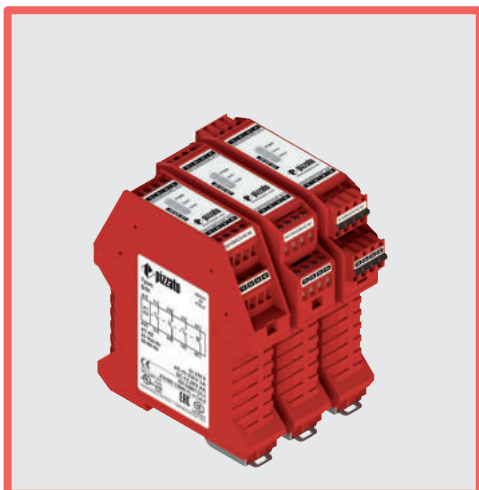

Module for emergency stops, end position monitoring for movable guards and magnetic safety sensors

Main features

- For safety applications up to SIL CL 3/PL e
- Input with 1 or 2 channels
- Choice between automatic start, manual start or monitored start
- Connection of input channels of opposite potentials
- Reduced housing width of 22.5 mm
- Output contacts:
3 NO safety contacts,
1 NC auxiliary contact
- Supply voltage:
24 Vac/dc, 120 Vac, 230 Vac

Utilization categories

Alternating current: AC15 (50...60 Hz)

U_e (V) 230

I_e (A) 3

Direct current: DC13 (6 oper. cycles/min.)

U_e (V) 24

I_e (A) 4

Quality marks:



EC type examination certificate: IMQ CP 432 DM

UL approval: E131787

CCC approval: 2020970305002290

EAC approval: RU C-IT.YT03.B.00035/19

Compliance with the requirements of:

Machinery Directive 2006/42/EC,

EMC Directive 2014/30/EC,

RoHS Directive 2011/65/EU.

Technical data

Housing

Polyamide housing PA 66, self-extinguishing V0 acc. to UL 94

Protection degree acc. to EN 60529:

IP40 (housing), IP20 (terminal strip)

Dimensions:

see page 355, design A

General data

SIL level (SIL CL) up to:

SIL CL 3 acc. to EN 62061

Performance Level (PL) up to:

PL e acc. to EN ISO 13849-1

Safety category up to:

cat. 4 acc. to EN ISO 13849-1

Safety parameters:

see page 417

Ambient temperature:

-25°C...+55°C

Mechanical endurance:

>10 million operating cycles

Electrical endurance:

>100,000 operating cycles

Pollution degree:

external 3, internal 2

Rated impulse withstand voltage (U_{imp}):

4 kV

Rated insulation voltage (U_i):

250 V

Overtoltage category:

II

Supply

Rated supply voltage (U_n):

24 Vac/dc; 50...60 Hz

120 Vac; 50...60 Hz

230 Vac; 50...60 Hz

Max. DC residual ripple in DC:

10%

Supply voltage tolerance:

±15% of U_n

Power consumption AC:

< 5 VA

Power consumption DC:

< 2 W

Control circuit

Protection against short circuits:

PTC resistance, I_h=0.5 A

PTC times:

response time > 100 ms, release time > 3 s

Maximum resistance per input:

≤ 50 Ω

Current per input:

30 mA (typical)

Min. duration of start impulse t_{MIN}:

> 100 ms

Response time t_A:

< 50 ms

Release time t_{R1}:

< 20 ms

Release time in absence of power supply t_{R2}:

< 70 ms

Simultaneity time t_C:

unlimited

In compliance with standards:

EN 60204-1, EN ISO 13855, EN ISO 14118, EN ISO 12100, EN ISO 13850, EN 60529, EN 61000-6-2, EN 61000-6-3, EN 61326-1, EN 60664-1, EN 60947-1, EN IEC 63000, EN ISO 13849-1, EN ISO 13849-2, EN 62061, UL 508, CSA C22.2 n° 14-95, GB/T14048.5

Output circuit

Output contacts:

3 NO safety contacts

1 NC auxiliary contact

Contact type:

forcibly guided

Material of the contacts:

gold-plated silver alloy

Maximum switching voltage:

230/240 Vac; 300 Vdc

Max. current per contact:

6 A

Conventional free air thermal current I_{th}:

6 A

Max. total current Σ I_{th}²:

64 A²

Minimum current:

10 mA

Contact resistance:

≤ 100 mΩ

External protection fuse:

4 A

The number and the load capacity of output contacts can be increased by using expansion modules or contactors. See pages 295-304.

Code structure

CS AR-04V024

Connection type	
V	Screw terminals
M	Connector with screw terminals
X	Connector with spring terminals

Supply voltage	
024	24 Vac/dc
120	120 Vac
230	230 Vac

Features approved by UL

Rated supply voltage (U _n):	24 Vac/dc; 50...60 Hz 120 Vac; 50...60 Hz 230 Vac; 50...60 Hz
Power consumption AC:	< 5 VA
Power consumption DC:	< 4 W
Electrical ratings:	230/240 Vac 6 A general use C300 pilot duty

Notes:

- Use 60 or 75°C copper (Cu) conductor and wire size No. 30-12 AWG, stranded or solid.
- The terminal tightening torque of 5-7 lb in.
- Only for 24 Vac/dc versions: supply from remote Class 2 source or limited voltage limited energy.



Safety module CS AR-04

Pin assignment

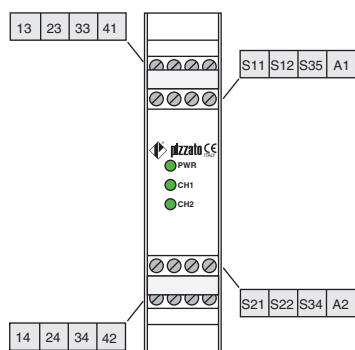

Internal block diagram

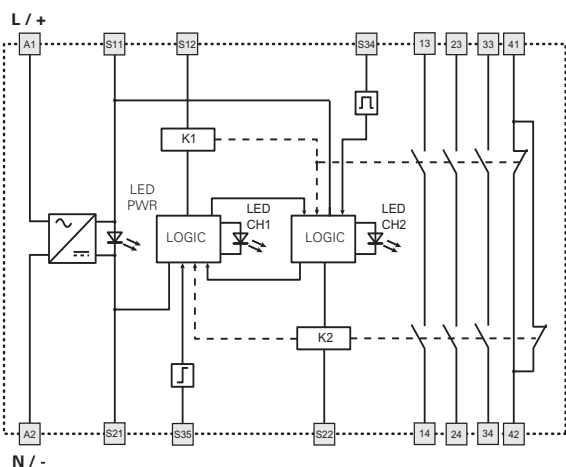

Input configuration

Emergency stop circuits	
Input configuration with manual start	
1 channel	2 channels

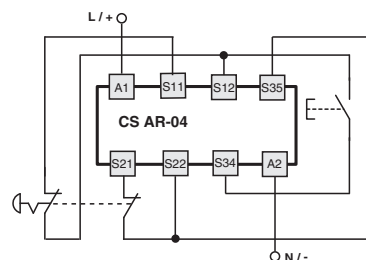
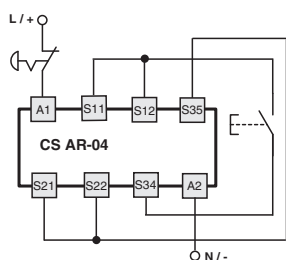

The diagram does not show the exact position of the terminals in the product

Automatic start

With regard to the indicated diagrams, bridge the start button between S12 and S34 in order to activate the automatic start module.

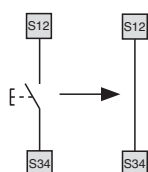

Monitored start

With regard to the indicated diagrams, remove the connection between the S22 and S35 terminals in order to activate the monitored start module.

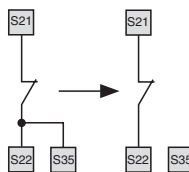

Monitoring of movable guards and magnetic safety sensors

The safety module can monitor emergency stop circuits, control circuits for movable guards as well as magnetic safety sensors. Replace the emergency stop contacts with switch contacts or sensor contacts. The sensors can only be used in 2-channel configuration.

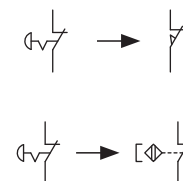

Function diagrams

Configuration with automatic start

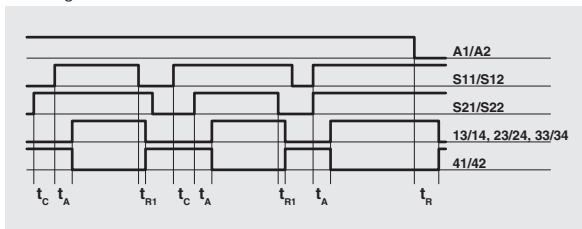

Configuration with monitored start

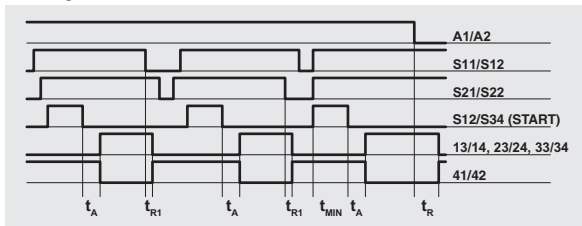

Configuration with manual start

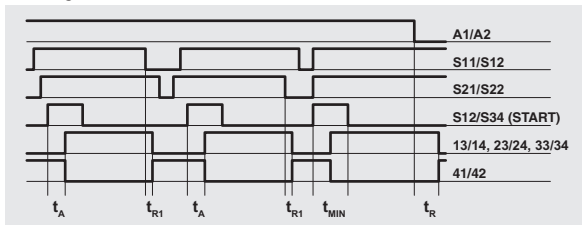

Legend:

- t_{MIN} : Min. duration of start impulse
- t_C : simultaneity time
- t_A : response time
- t_{R1} : release time
- t_{R2} : release time in absence of power supply

Notes:

The configurations with one channel are obtained taking into consideration only the effect of the S11/S12 input on the supply. In this case it is necessary to consider time t_{R1} referred to input S11/S12, time t_R referred to the supply, time t_A referred to input S11/S12 and to the start, and time t_{MIN} .

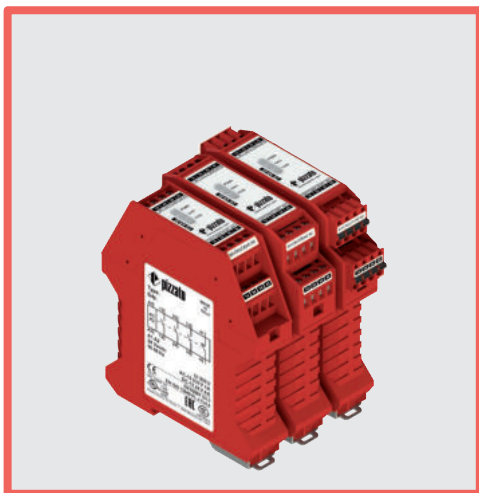

Module for emergency stops, end position monitoring for movable guards, OSSD semiconductor outputs and magnetic safety sensors

Main features

- For safety applications up to SIL CL 3/PL e
- Input with 1 or 2 channels
- Choice between automatic start, manual start (CS AR-05 only) or monitored start (CS AR-06 only)
- Can be connected to OSSD semiconductor outputs, to electromechanical contacts or to magnetic safety sensors
- Output contacts:
3 NO safety contacts,
1 NC auxiliary contact
- Supply voltage:
24 Vac/dc, 120 Vac, 230 Vac

Utilization categories

Alternating current: AC15 (50...60 Hz)

U_e (V) 230

I_e (A) 3

Direct current: DC13 (6 oper. cycles/min.)

U_e (V) 24

I_e (A) 4

Quality marks:



EC type examination certificate: IMQ CP 432 DM

UL approval: E131787

CCC approval: 2020970305002290

EAC approval: RU C-IT.YT03.B.00035/19

Compliance with the requirements of:

Machinery Directive 2006/42/EC,

EMC Directive 2014/30/EC,

RoHS Directive 2011/65/EU.

Technical data

Housing

Polyamide housing PA 66, self-extinguishing V0 acc. to UL 94

Protection degree acc. to EN 60529:

IP40 (housing), IP20 (terminal strip)

Dimensions:

see page 355, design A

General data

SIL level (SIL CL) up to:

SIL CL 3 acc. to EN 62061

Performance Level (PL) up to:

PL e acc. to EN ISO 13849-1

Safety category up to:

cat. 4 acc. to EN ISO 13849-1

Safety parameters:

see page 417

Ambient temperature:

-25°C...+55°C

Mechanical endurance:

>10 million operating cycles

Electrical endurance:

>100,000 operating cycles

Pollution degree:

external 3, internal 2

Rated impulse withstand voltage (U_{imp}):

4 kV

Rated insulation voltage (U_i):

250 V

Overtoltage category:

II

Supply

Rated supply voltage (U_n):

24 Vac/dc; 50...60 Hz

120 Vac; 50...60 Hz

230 Vac; 50...60 Hz

Max. DC residual ripple in DC:

10%

Supply voltage tolerance:

±15% of U_n

Power consumption AC:

< 5 VA

Power consumption DC:

< 2 W

Control circuit

Protection against short circuits:

PTC resistance, I_h=0.5 A

PTC times:

response time > 100 ms, release time > 3 s

Maximum resistance per input:

≤ 50 Ω

Current per input:

< 30 mA

Min. duration of start impulse t_{MIN}:

> 250 ms

Response time t_A:

< 200 ms

Release time t_{R1}:

< 15 ms

Release time in absence of power supply t_R:

< 70 ms

Simultaneity time t_c:

unlimited

In compliance with standards:

EN 60204-1, EN ISO 13855, EN ISO 14118, EN ISO 12100, EN ISO 13850, EN 60529, EN 61000-6-2, EN 61000-6-3, EN 61326-1, EN 60664-1, EN 60947-1, EN IEC 63000, EN ISO 13849-1, EN ISO 13849-2, EN 62061, UL 508, CSA C22.2 n° 14-95, GB/T14048.5

Output circuit

Output contacts:

3 NO safety contacts

1 NC auxiliary contact

forcibly guided

Contact type:

gold-plated silver alloy

Material of the contacts:

Maximum switching voltage:

230/240 Vac; 300 Vdc

Max. current per contact:

6 A

Conventional free air thermal current I_{th}:

6 A

Max. total current Σ I_{th}²:

64 A²

Minimum current:

10 mA

Contact resistance:

≤ 100 mΩ

External protection fuse:

4 A

The number and the load capacity of output contacts can be increased by using expansion modules or contactors. See pages 295-304.

Code structure

CS AR-05V024

Start mode

05 manual or automatic start

06 monitored start

Connection type

V Screw terminals

M Connector with screw terminals

X Connector with spring terminals

Supply voltage

024 24 Vac/dc

120 120 Vac

230 230 Vac

Features approved by UL

Rated supply voltage (U_n):

24 Vac/dc; 50...60 Hz

120 Vac; 50...60 Hz

230 Vac; 50...60 Hz

Power consumption AC:

< 5 VA

Power consumption DC:

< 4 W

Electrical ratings:

230/240 Vac

6 A general use

C300 pilot duty

Notes:
- Use 60 or 75°C copper (Cu) conductor and wire size No. 30-12 AWG, stranded or solid.
- The terminal tightening torque of 5-7 lb in.
- Only for 24 Vac/dc versions: supply from remote Class 2 source or limited voltage limited energy.



Safety module CS AR-05 / CS AR-06

Pin assignment

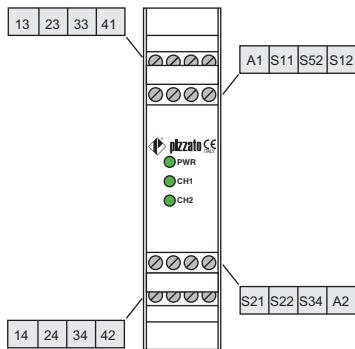

Internal block diagram

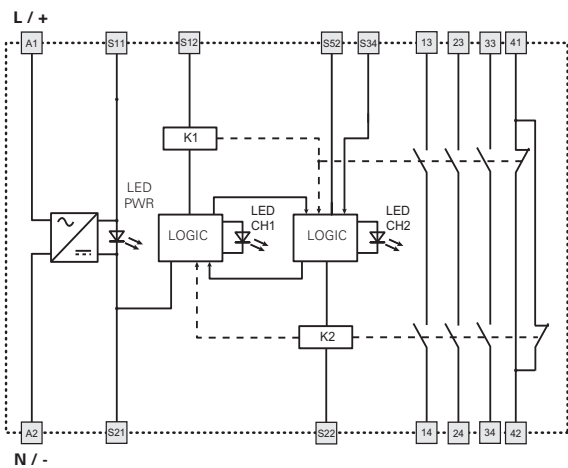

Input configuration

OSSD semiconductor outputs (e.g. ST, NS, NG series or light barriers)
 Input configuration with manual start (CS AR-05)
 1 channel 2 channels

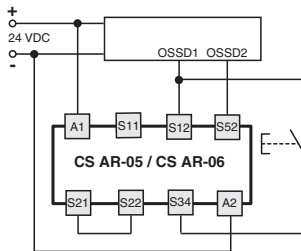
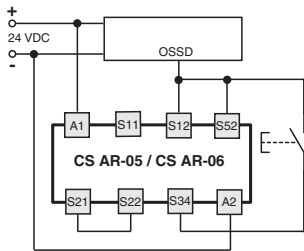

Emergency stop circuits

Input configuration with manual start (CS AR-05)
 1 channel 2 channels

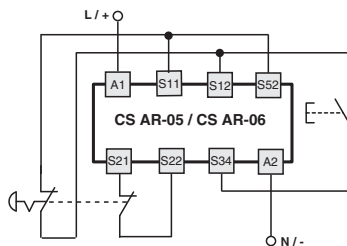
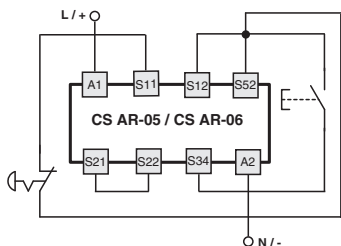

The diagram does not show the exact position of the terminals in the product

Function diagrams

Configuration with automatic start (CS AR-05 only)

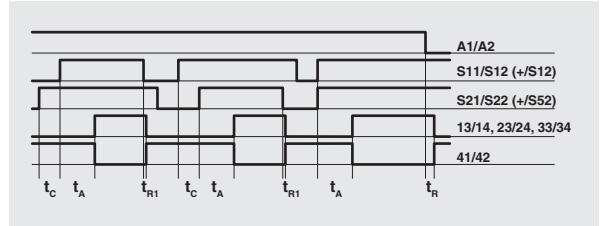

Configuration with monitored start (CS AR-06 only)

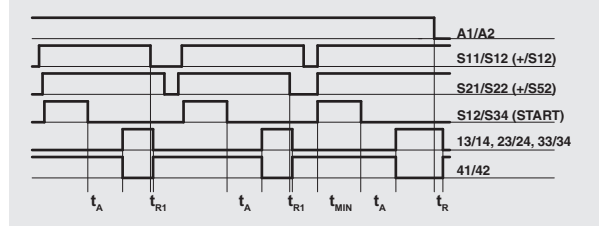

Configuration with manual start (CS AR-05 only)

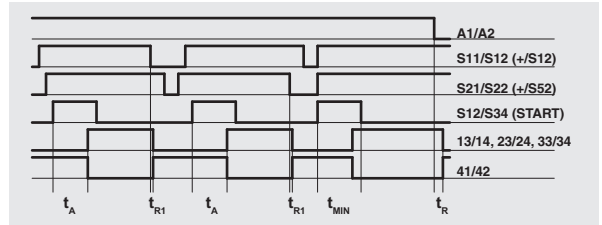

- Legend:
- t_{MIN} : Min. duration of start impulse
 - t_C : simultaneity time
 - t_A : response time
 - t_{R1} : release time
 - t_R : release time in absence of power supply

Notes:
 The configurations with one channel are obtained taking into consideration the CH1 input only. In this case it is necessary to consider time t_{R1} referred to input CH1, time t_R referred to the supply, time t_A referred to input CH1 and to the start, and time t_{MIN} referred to the start.

Automatic start (CS AR-05 only)

Bridge the start button between S12 and S34 in order to activate the automatic start module.

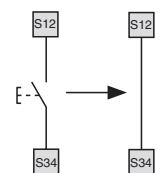

Monitored start

Use module CS AR-06 with the circuit diagrams for manual start.

Monitoring of movable guards and magnetic safety sensors

The safety module can monitor emergency stop circuits, control circuits for movable guards as well as magnetic safety sensors. Replace the emergency stop contacts with switch contacts or sensor contacts. The sensors can only be used in 2-channel configuration.

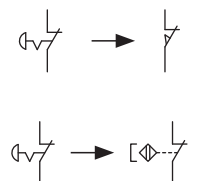



Module for emergency stops and end position monitoring for movable guards

Main features

- For safety applications up to SIL CL 3/PL e
- Input with 1 or 2 channels
- Choice between automatic start, manual start or monitored start
- Connection of input channels of opposite potentials
- Reduced housing width of 22.5 mm
- Output contacts:
 - 4 NO safety contacts,
 - 1 NC auxiliary contact
- Supply voltage:
 - 24 Vac/dc

Utilization categories

Alternating current: AC15 (50...60 Hz)

U_e (V) 230

I_e (A) 3

Direct current: DC13 (6 oper. cycles/min.)

U_e (V) 24

I_e (A) 4

Quality marks:



EC type examination certificate: IMQ CP 432 DM

UL approval: E131787

CCC approval: 2020970305002290

EAC approval: RU C-IT.YT03.B.00035/19

Compliance with the requirements of:

Machinery Directive 2006/42/EC,

EMC Directive 2014/30/EC,

RoHS Directive 2011/65/EU.

Technical data

Housing

Polyamide housing PA 66, self-extinguishing V0 acc. to UL 94

Protection degree acc. to EN 60529:

IP40 (housing), IP20 (terminal strip)

Dimensions:

see page 355, design B

General data

SIL level (SIL CL) up to:

SIL CL 3 acc. to EN 62061

Performance Level (PL) up to:

PL e acc. to EN ISO 13849-1

Safety category up to:

cat. 4 acc. to EN ISO 13849-1

Safety parameters:

see page 417

Ambient temperature:

-25°C...+55°C

Mechanical endurance:

>10 million operating cycles

Electrical endurance:

>100,000 operating cycles

Pollution degree:

external 3, internal 2

Rated impulse withstand voltage (U_{imp}):

4 kV

Rated insulation voltage (U_i):

250 V

Overvoltage category:

II

Supply

Rated supply voltage (U_n):

24 Vac/dc; 50...60 Hz

Max. DC residual ripple in DC:

10%

Supply voltage tolerance:

±15% of U_n

Power consumption AC:

< 5 VA

Power consumption DC:

< 2 W

Control circuit

Protection against short circuits:

PTC resistance, I_h=0.5 A

PTC times:

response time > 100 ms, release time > 3 s

Maximum resistance per input:

≤ 50 Ω

Current per input:

30 mA (typical)

Min. duration of start impulse t_{MIN}:

> 100 ms

Response time t_A:

< 70 ms

Release time t_{R1}:

< 40 ms

Release time in absence of power supply t_R:

< 80 ms

Simultaneity time t_c:

unlimited

In compliance with standards:

EN 60204-1, EN ISO 13855, EN ISO 14118, EN ISO 12100, EN ISO 13850, EN 60529, EN 61000-6-2, EN 61000-6-3, EN 61326-1, EN 60664-1, EN 60947-1, EN IEC 63000, EN ISO 13849-1, EN ISO 13849-2, EN 62061, UL 508, CSA C22.2 n° 14-95, GB/T14048.5

Output circuit

Output contacts:

4 NO safety contacts

1 NC auxiliary contact

Contact type:

forcibly guided

Material of the contacts:

gold-plated silver alloy

Maximum switching voltage:

230/240 Vac; 220 Vdc

Max. current per contact:

6 A

Conventional free air thermal current I_{th}:

6 A

Max. total current Σ I_{th}²:

72 A²

Minimum current:

10 mA

Contact resistance:

≤ 100 mΩ

External protection fuse:

4 A

The number and the load capacity of output contacts can be increased by using expansion modules or contactors. See pages 295-304.

Code structure

CS AR-07M024

Connection type

M Connector with screw terminals

X Connector with spring terminals

Supply voltage

024 24 Vac/dc

Features approved by UL

Rated supply voltage (U_n): 24 Vac/dc; 50...60 Hz

Power consumption AC: < 5 VA

Power consumption DC: < 4 W

Electrical ratings: 230/240 Vac

6 A general use

C300 pilot duty

Notes:

- Use 60 or 75°C copper (Cu) conductor and wire size No. 30-12 AWG, stranded or solid.

- The terminal tightening torque of 5-7 lb in.

- Only for 24 Vac/dc versions: supply from remote Class 2 source or limited voltage limited energy.



Safety module CS AR-07

Pin assignment

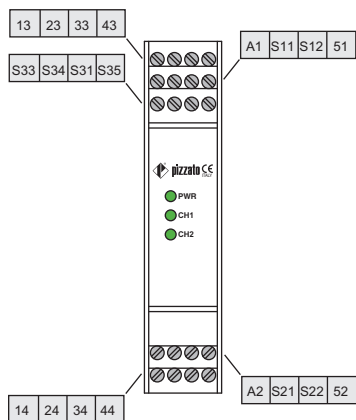

Internal block diagram

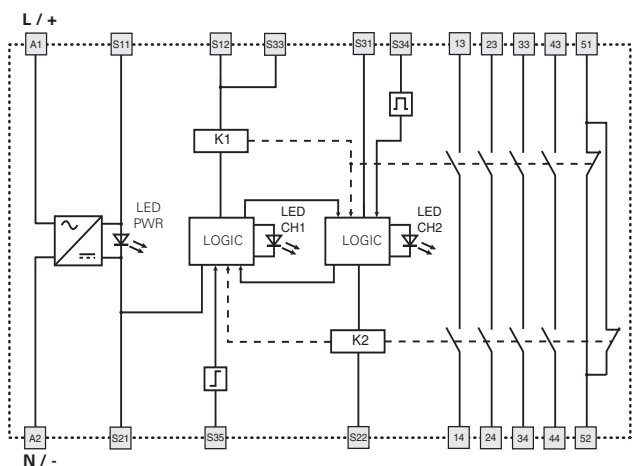

Input configuration

Emergency stop circuits	
Input configuration with manual start	
1 channel	2 channels

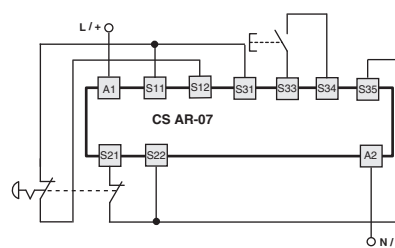
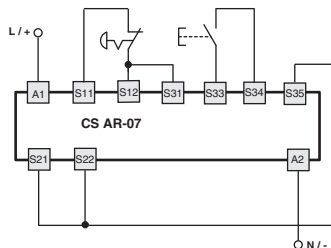

The diagram does not show the exact position of the terminals in the product

Automatic start

With regard to the indicated diagrams, bridge the start button between S33 and S34 in order to activate the automatic start module.

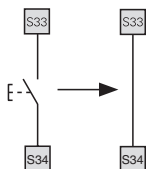

Monitored start

With regard to the indicated diagrams, remove the connection between the S22 and S35 terminals in order to activate the monitored start module.

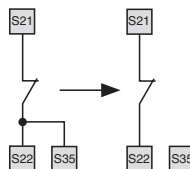

Movable guard monitoring

The safety module can monitor emergency stop circuits and control circuits for movable guards. Replace the emergency stop contacts with the switch contacts.

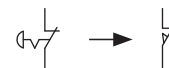

Function diagrams

Configuration with automatic start

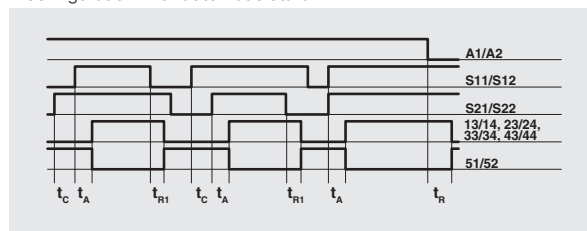

Configuration with monitored start

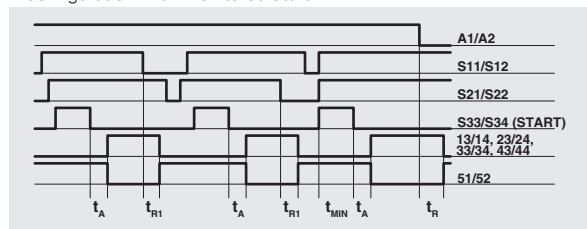

Configuration with manual start

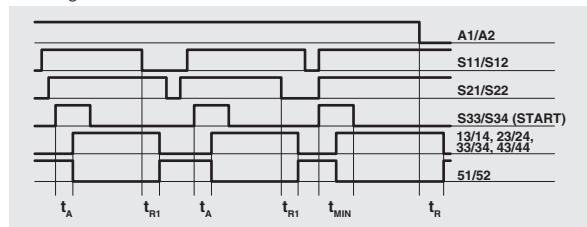

Legend:

- t_{MIN} : Min. duration of start impulse
- t_C : simultaneity time
- t_A : response time
- t_{R1} : release time
- t_R : release time in absence of power supply

Notes:

The configurations with one channel are obtained taking into consideration the S11/S12 input only. In this case it is necessary to consider time t_{R1} referred to input S11/S12, time t_R referred to the supply, time t_A referred to input S11/S12 and to the start, and time t_{MIN} referred to the start.

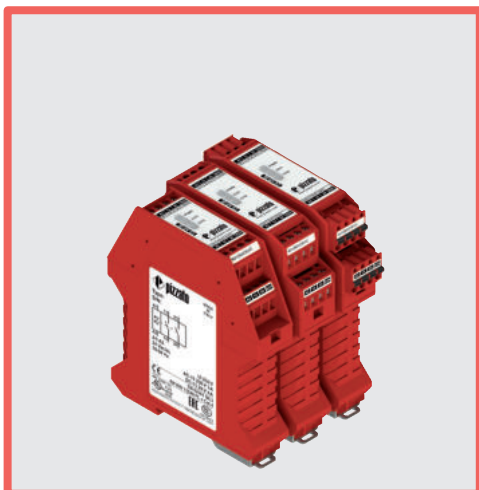

Module for emergency stops, end position monitoring for movable guards, OSSD semiconductor outputs and magnetic safety sensors

Main features

- For safety applications up to SIL CL 3/PL e
- Input with 1 or 2 channels
- Choice between automatic start, manual start or monitored start
- Can be connected to OSSD semiconductor outputs, to electromechanical contacts or to magnetic safety sensors
- Output contacts:
2 NO safety contacts
- Supply voltage:
12 Vdc, 24 Vac/dc, 120 Vac, 230 Vac
- Possibility of parallel reset of several modules

Utilization categories

Alternating current: AC15 (50...60 Hz)

U_e (V) 230

I_e (A) 3

Direct current: DC13 (6 oper. cycles/min.)

U_e (V) 24

I_e (A) 4

Quality marks:



EC type examination certificate: IMQ CP 432 DM

UL approval: E131787

CCC approval: 2020970305002290

TÜV SÜD approval: Z10 18 05 75157 018

EAC approval: RU C-IT.YT03.B.00035/19

Compliance with the requirements of:

Machinery Directive 2006/42/EC,

EMC Directive 2014/30/EC,

RoHS Directive 2011/65/EU.

Code structure

CS AR-08V024

Connection type	
V	Screw terminals
M	Connector with screw terminals
X	Connector with spring terminals

Supply voltage	
U12	12 Vdc
024	24 Vac/dc
120	120 Vac
230	230 Vac

Technical data

Housing

Polyamide housing PA 66, self-extinguishing V0 acc. to UL 94

Protection degree acc. to EN 60529:

IP40 (housing), IP20 (terminal strip)

Dimensions:

see page 355, design A

General data

SIL level (SIL CL) up to:

SIL CL 3 acc. to EN 62061

Performance Level (PL) up to:

PL e acc. to EN ISO 13849-1

Safety category up to:

cat. 4 acc. to EN ISO 13849-1

Safety parameters:

see page 417

Ambient temperature:

-25°C...+55°C

Mechanical endurance:

>10 million operating cycles

Electrical endurance:

>100,000 operating cycles

Pollution degree:

external 3, internal 2

Rated impulse withstand voltage (U_{imp}):

4 kV

Rated insulation voltage (U_i):

250 V

Overvoltage category:

II

Supply

Rated supply voltage (U_n):

12 Vdc
24 Vac/dc; 50...60 Hz
120 Vac; 50...60 Hz
230 Vac; 50...60 Hz

Max. DC residual ripple in DC:

10%

Supply voltage tolerance

±15% of U_n

24 Vac/dc, 120 Vac, 230 Vac:

Supply voltage tolerance 12 Vdc:

-10% ... +15% of U_n

Power consumption AC:

< 5 VA

Power consumption DC:

< 2 W

Control circuit

Protection against short circuits:

PTC resistance, I_h=0.5 A

PTC times:

response time > 100 ms, release time > 3 s

Maximum resistance per input:

≤ 50 Ω (15 Ω)*

Current per input:

30 mA (70 mA)* (typical)

Min. duration of start impulse t_{MIN}:

> 200 ms (100 ms)*

Response time t_A:

< 300 ms (220 ms)*

Release time t_{R1}:

< 20 ms (15 ms)*

Release time in absence of power supply t_{R2}:

< 200 ms (50 ms)*

Simultaneity time t_c:

unlimited

* Version CS AR-08•U12

In compliance with standards:

EN 60204-1, EN ISO 13855, EN ISO 14118, EN ISO 12100, EN ISO 13850, EN 60529, EN 61000-6-2, EN 61000-6-3, EN 61326-1, EN 60664-1, EN 60947-1, EN 60947-5-3, EN 61508-1, EN 61508-2, EN 61508-4, EN IEC 63000, EN ISO 13849-1, EN ISO 13849-2, EN 62061, UL 508, CSA C22.2 n° 14-95, GB/T14048.5

Output circuit

Output contacts:

2 NO safety contacts,

Contact type:

forcibly guided

Material of the contacts:

gold-plated silver alloy

Maximum switching voltage:

230/240 Vac; 300 Vdc

Max. current per contact:

6 A

Conventional free air thermal current I_{th}:

6 A

Max. total current Σ I_{th}²:

36 A²

Minimum current:

10 mA

Contact resistance:

≤ 100 mΩ

External protection fuse:

4 A

The number and the load capacity of output contacts can be increased by using expansion modules or contactors. See pages 295-304.

Features approved by UL

Rated supply voltage (U_n): 24 Vac/dc; 50...60 Hz, 120 Vac; 50...60 Hz
230 Vac; 50...60 Hz

Power consumption AC: < 5 VA

Power consumption DC: < 4 W

Electrical ratings: 230/240 Vac, 6 A general use, C300 pilot duty

Notes:

- Use 60 or 75°C copper (Cu) conductor and wire size No. 30-12 AWG, stranded or solid.

- The terminal tightening torque of 5-7 lb in.

- Only for 24 Vac/dc versions: supply from remote Class 2 source or limited voltage limited energy.

Features approved by TÜV SÜD

Rated supply voltage (U_n): 24 Vac/dc ± 15%,
120 Vac ± 15%, 230 Vac ± 15%

Power consumption: 5 VA max AC, 2 W max DC

Rated operating current (max.): 4 A

Maximum switching load (max.): 1380 VA

Ambient temperature: -25°C ... +55°C

Storage temperature: -25°C ... +70°C

Protection degree: IP40 (housing), IP20 (terminal strip)

In compliance with standards: 2006/42/EC Machinery Directive,

EN ISO 13849-1:2015 (fino a Cat. 4 PL e), EN 60947-5-3:2013,

EN 61508-1:2010 (fino a SIL 3), EN 61508-2:2010 (fino a SIL 3),

EN 61508-4:2010 (fino a SIL 3), EN 62061:2005/A2:2015 (fino a SIL CL 3)



Safety module CS AR-08

Pin assignment

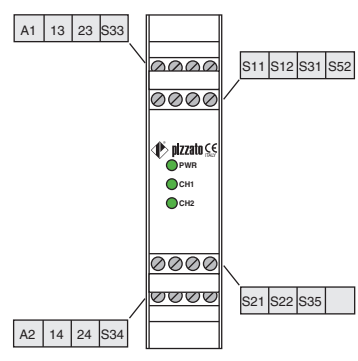

Function diagrams

Configuration with automatic start

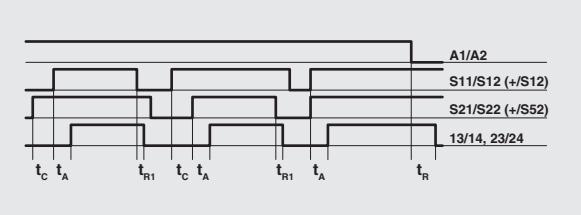

Configuration with monitored start

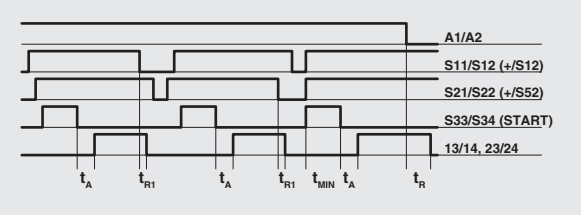

Configuration with manual start

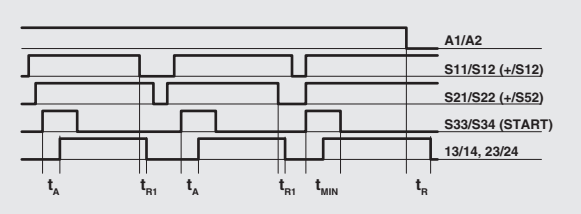

Legend:

- t_{MIN} : Min. duration of start impulse
- t_c : simultaneity time
- t_A : response time
- t_{R1} : release time
- t_R : release time in absence of power supply

Notes:

The configurations with one channel are obtained taking into consideration the CH1 input only. In this case it is necessary to consider time t_{R1} referred to input CH1, time t_A referred to the supply, time t_A referred to input CH1 and to the start, and time t_{MIN} referred to the start.

Internal block diagram

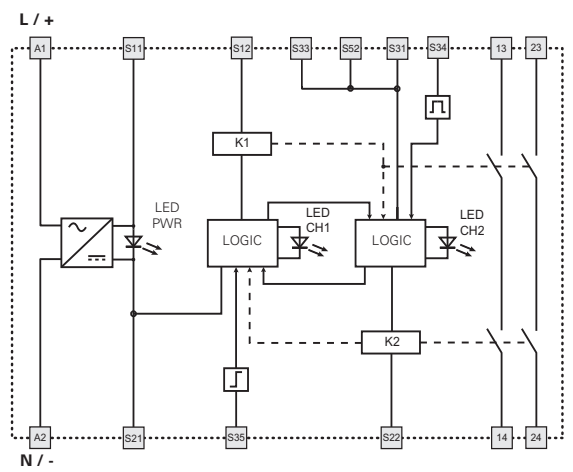

Input configuration

OSSD semiconductor outputs (e.g. ST, NS, NG series or light barriers)

Input configuration with manual start

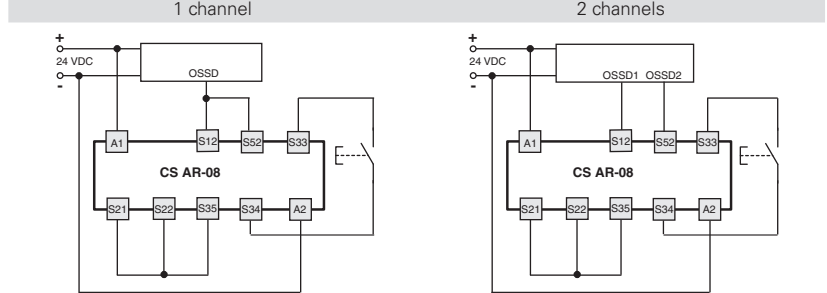

Automatic start

With regard to the indicated diagrams, bridge the start button between S33 and S34 in order to activate the automatic start module.

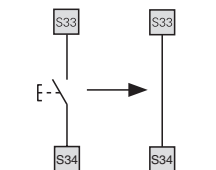

Monitored start

With regard to the indicated diagrams, remove the connection between the S22 and S35 terminals in order to activate the monitored start module.

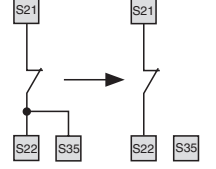

Emergency stop circuits

Input configuration with manual start

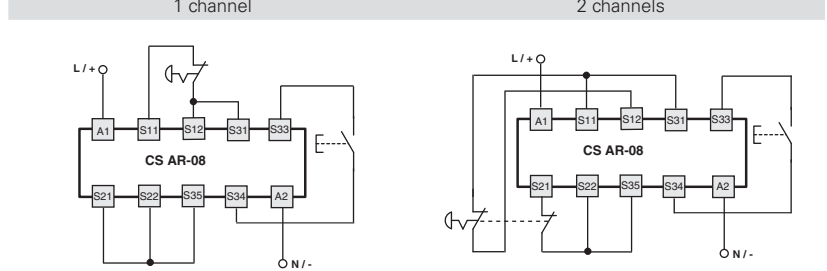

Monitoring of movable guards and magnetic safety sensors

The safety module can monitor emergency stop circuits, control circuits for movable guards as well as magnetic safety sensors. Replace the emergency stop contacts with switch contacts or sensor contacts. The sensors can only be used in 2-channel configuration.

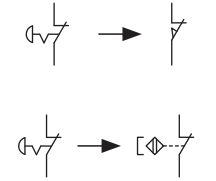

The diagram does not show the exact position of the terminals in the product

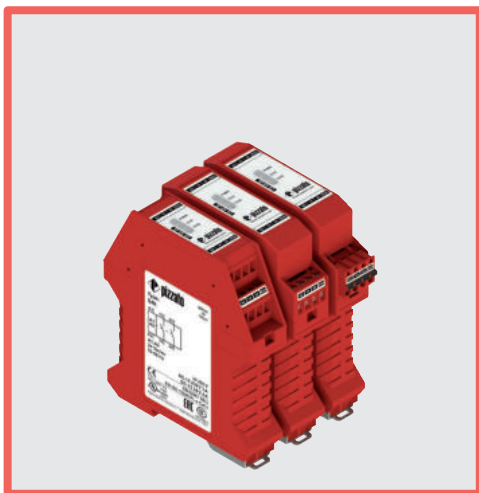

Module for emergency stops and end position monitoring for movable guards

Main features

- For safety applications up to SIL CL 3/PL e
- Input with 1 or 2 channels
- Choice between automatic start, manual start (CS AR-20 only) or monitored start (CS AR-21 only)
- Reduced housing width of 22.5 mm
- 2 NO safety contacts
- Supply voltage: 24 Vac/dc, 120 Vac, 230 Vac

Utilization categories

Alternating current: AC15 (50...60 Hz)

U_e (V) 230

I_e (A) 3

Direct current: DC13 (6 oper. cycles/min.)

U_e (V) 24

I_e (A) 4

Quality marks:



EC type examination certificate: IMQ CP 432 DM

UL approval: E131787

CCC approval: 2020970305002290

EAC approval: RU C-IT.YT03.B.00035/19

Compliance with the requirements of:

Machinery Directive 2006/42/EC,

EMC Directive 2014/30/EC,

RoHS Directive 2011/65/EU.

Technical data

Housing

Polyamide housing PA 66, self-extinguishing V0 acc. to UL 94

Protection degree acc. to EN 60529:

IP40 (housing), IP20 (terminal strip)

Dimensions:

see page 355, design A

General data

SIL level (SIL CL) up to:

SIL CL 3 acc. to EN 62061

Performance Level (PL) up to:

PL e acc. to EN ISO 13849-1

Safety category up to:

cat. 3 acc. to EN ISO 13849-1

Safety parameters:

see page 417

Ambient temperature:

-25°C...+55°C

Mechanical endurance:

>10 million operating cycles

Electrical endurance:

>100,000 operating cycles

Pollution degree:

external 3, internal 2

Rated impulse withstand voltage (U_{imp}):

4 kV

Rated insulation voltage (U_i):

250 V

Overvoltage category:

II

Supply

Rated supply voltage (U_n):

24 Vac/dc; 50...60 Hz

120 Vac; 50...60 Hz

230 Vac; 50...60 Hz

Max. DC residual ripple in DC:

10%

Supply voltage tolerance:

±15% of U_n

Power consumption AC:

< 5 VA

Power consumption DC:

< 2 W

Control circuit

Protection against short circuits:

PTC resistance, I_h=0.5 A

PTC times:

response time > 100 ms, release time > 3 s

Maximum resistance per input:

≤ 50 Ω

Current per input:

70 mA (typical)

Min. duration of start impulse t_{MIN}:

> 100 ms

Response time t_A:

< 50 ms

Release time in absence of power supply t_R:

< 100 ms

Simultaneity time t_C:

unlimited

In compliance with standards:

EN 60204-1, EN ISO 13855, EN ISO 14118, EN ISO 12100, EN ISO 13850, EN 60529, EN 61000-6-2, EN 61000-6-3, EN 61326-1, EN 60664-1, EN 60947-1, EN IEC 63000, EN ISO 13849-1, EN ISO 13849-2, EN 62061, UL 508, CSA C22.2 n° 14-95, GB/T14048.5

Output circuit

Output contacts:

2 NO safety contacts

Contact type:

forcibly guided

Material of the contacts:

gold-plated silver alloy

Maximum switching voltage:

230/240 Vac; 300 Vdc

Max. current per contact:

6 A

Conventional free air thermal current I_{th}:

6 A

Max. total current Σ I_{th}²:

36 A²

Minimum current:

10 mA

Contact resistance:

≤ 100 mΩ

External protection fuse:

4 A

The number and the load capacity of output contacts can be increased by using expansion modules or contactors. See pages 295-304.

Code structure

CS AR-20V024

Start mode

20 manual or automatic start

21 monitored start

Connection type

V Screw terminals

M Connector with screw terminals

X Connector with spring terminals

Supply voltage

024 24 Vac/dc

120 120 Vac

230 230 Vac

Features approved by UL

Rated supply voltage (U_n): 24 Vac/dc; 50...60 Hz

120 Vac; 50...60 Hz

230 Vac; 50...60 Hz

Power consumption AC:

< 5 VA

Power consumption DC:

< 4 W

Electrical ratings:

230/240 Vac

6 A general use

C300 pilot duty

Notes:

- Use 60 or 75°C copper (Cu) conductor and wire size No. 30-12 AWG, stranded or solid.

- The terminal tightening torque of 5-7 lb in.

- Only for 24 Vac/dc versions: supply from remote Class 2 source or limited voltage limited energy.



Safety module CS AR-20 / CS AR-21

Pin assignment

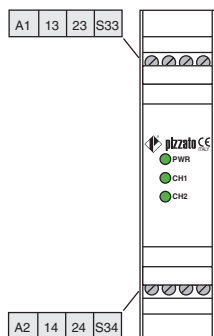

Internal block diagram

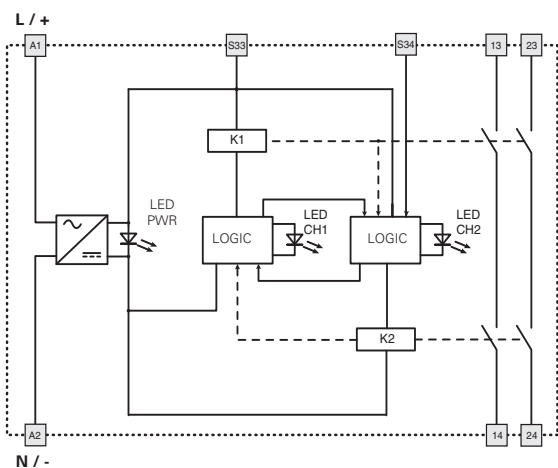

Function diagrams

Configuration with automatic start (CS AR-20 only)

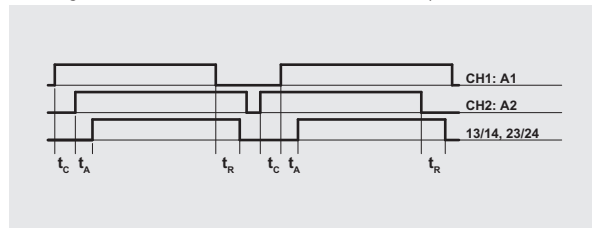

Configuration with monitored start (CS AR-21 only)

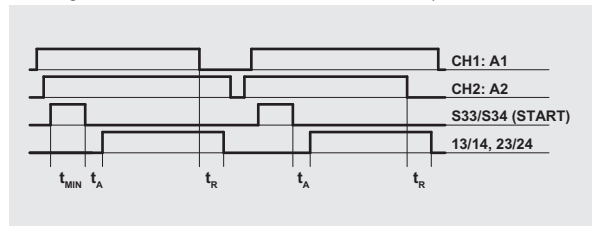

Configuration with manual start (CS AR-20 only)

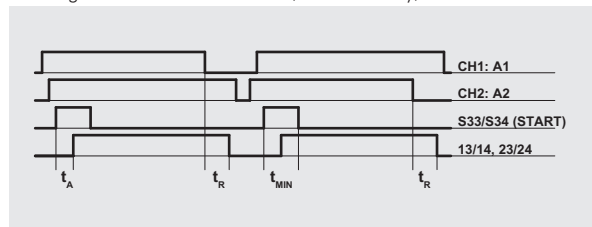

Legend:
 t_{MIN} : Min. duration of start impulse
 t_c : simultaneity time
 t_A : response time
 t_R : release time in absence of power supply

Notes:
 The configurations with one channel are obtained taking into consideration the CH1:A1 input only. In this case it is necessary to consider time t_R referred to input CH1:A1, time t_A referred to input CH1:A1 and to the start, and time t_{MIN} referred to the start.

Input configuration

Emergency stop circuits	
Input configuration with manual start	
1 channel	2 channels

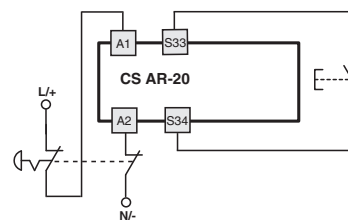
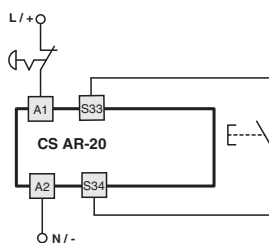

The diagram does not show the exact position of the terminals in the product

Automatic start

With regard to the indicated diagrams, bridge the start button between S33 and S34 in order to activate the automatic start module.

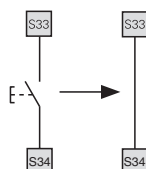

Monitored start

Use module CS AR-21 with the circuit diagrams for manual start.

Movable guard monitoring

The safety module can monitor emergency stop circuits and control circuits for movable guards. Replace the emergency stop contacts with the switch contacts.

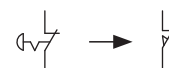

Application examples See page 305

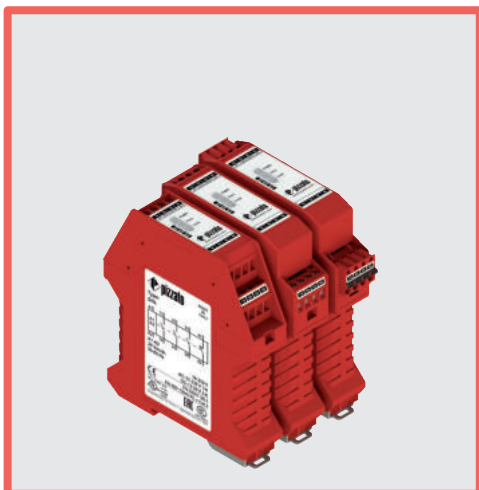

Module for emergency stops and end position monitoring for movable guards

Main features

- For safety applications up to SIL CL 3/PL e
- Input with 1 or 2 channels
- Choice between automatic start, manual start (CS AR-22 only) or monitored start (CS AR-23 only)
- Reduced housing width of 22.5 mm
- 3 NO safety contacts, 1 NC auxiliary contact
- Supply voltage: 24 Vac/dc, 120 Vac, 230 Vac

Utilization categories

Alternating current: AC15 (50...60 Hz)

U_e (V) 230

I_e (A) 3

Direct current: DC13 (6 oper. cycles/min.)

U_e (V) 24

I_e (A) 4

Quality marks:



EC type examination certificate: IMQ CP 432 DM

UL approval: E131787

CCC approval: 2020970305002290

EAC approval: RU C-IT.YT03.B.00035/19

Compliance with the requirements of:

Machinery Directive 2006/42/EC,

EMC Directive 2014/30/EC,

RoHS Directive 2011/65/EU.

Technical data

Housing

Polyamide housing PA 66, self-extinguishing V0 acc. to UL 94

Protection degree acc. to EN 60529:

IP40 (housing), IP20 (terminal strip)

Dimensions:

see page 355, design A

General data

SIL level (SIL CL) up to:

SIL CL 3 acc. to EN 62061

Performance Level (PL) up to:

PL e acc. to EN ISO 13849-1

Safety category up to:

cat. 3 acc. to EN ISO 13849-1

Safety parameters:

see page 417

Ambient temperature:

-25°C...+55°C

Mechanical endurance:

>10 million operating cycles

Electrical endurance:

>100,000 operating cycles

Pollution degree:

external 3, internal 2

Rated impulse withstand voltage (U_{imp}):

4 kV

Rated insulation voltage (U_i):

250 V

Overvoltage category:

II

Supply

Rated supply voltage (U_n):

24 Vac/dc; 50...60 Hz

120 Vac; 50...60 Hz

230 Vac; 50...60 Hz

Max. DC residual ripple in DC:

10%

Supply voltage tolerance:

±15% of U_n

Power consumption AC:

< 5 VA

Power consumption DC:

< 2 W

Control circuit

Protection against short circuits:

PTC resistance, I_h=0.5 A

PTC times:

response time > 100 ms, release time > 3 s

Maximum resistance per input:

≤ 50 Ω

Current per input:

70 mA (typical)

Min. duration of start impulse t_{MIN}:

> 100 ms

Response time t_A:

< 50 ms

Release time in absence of power supply t_R:

< 75 ms

Simultaneity time t_C:

unlimited

In compliance with standards:

EN 60204-1, EN ISO 13855, EN ISO 14118, EN ISO 12100, EN ISO 13850, EN 60529, EN 61000-6-2, EN 61000-6-3, EN 61326-1, EN 60664-1, EN 60947-1, EN IEC 63000, EN ISO 13849-1, EN ISO 13849-2, EN 62061, UL 508, CSA C22.2 n° 14-95, GB/T14048.5

Output circuit

Output contacts:

3 NO safety contacts

1 NC auxiliary contact

forcibly guided

Contact type:

gold-plated silver alloy

Material of the contacts:

Maximum switching voltage:

230/240 Vac; 300 Vdc

Max. current per contact:

6 A

Conventional free air thermal current I_{th}:

6 A

Max. total current Σ I_{th}²:

80 A²

Minimum current:

10 mA

Contact resistance:

≤ 100 mΩ

External protection fuse:

4 A

The number and the load capacity of output contacts can be increased by using expansion modules or contactors. See pages 295-304.

Code structure

CS AR-22V024

Start mode

22 manual or automatic start

23 monitored start

Supply voltage

024 24 Vac/dc

120 120 Vac

230 230 Vac

Connection type

V Screw terminals

M Connector with screw terminals

X Connector with spring terminals

Features approved by UL

Rated supply voltage (U_n):

24 Vac/dc; 50...60 Hz

120 Vac; 50...60 Hz

230 Vac; 50...60 Hz

Power consumption AC:

< 5 VA

Power consumption DC:

< 4 W

Electrical ratings:

230/240 Vac

6 A general use

C300 pilot duty

Notes:

- Use 60 or 75°C copper (Cu) conductor and wire size No. 30-12 AWG, stranded or solid.

- The terminal tightening torque of 5-7 lb in.

- Only for 24 Vac/dc versions: supply from remote Class 2 source or limited voltage limited energy.



Safety module CS AR-22 / CS AR-23

Pin assignment

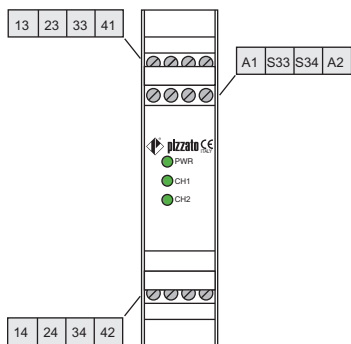

Internal block diagram

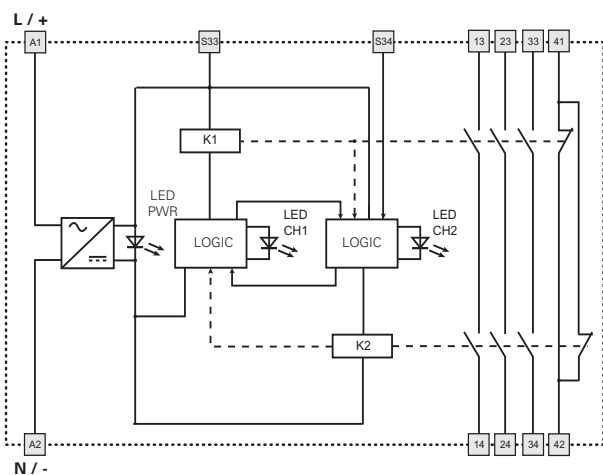

Input configuration

Emergency stop circuits	
Input configuration with manual start	
1 channel	2 channels

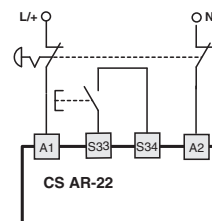
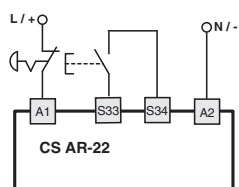

The diagram does not show the exact position of the terminals in the product

Automatic start

With regard to the indicated diagrams, bridge the start button between S33 and S34 in order to activate the automatic start module.

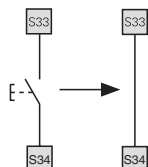

Monitored start

Use module CS AR-23 with the circuit diagrams for manual start.

Movable guard monitoring

The safety module can monitor emergency stop circuits and control circuits for movable guards. Replace the emergency stop contacts with the switch contacts.

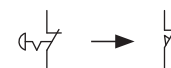

Function diagrams

Configuration with automatic start (CS AR-22 only)

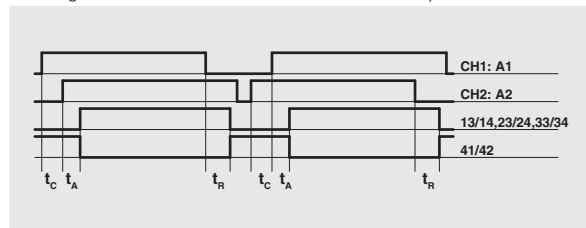

Configuration with monitored start (CS AR-23 only)

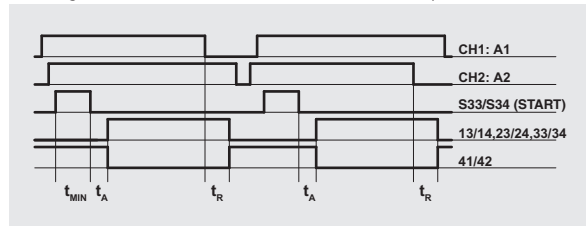

Configuration with manual start (CS AR-22 only)

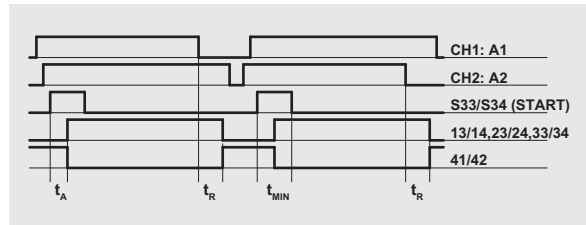

Legend:

t_{MIN} : Min. duration of start impulse t_A : response time
 t_C : simultaneity time t_R : release time in absence of power supply

Notes:

The configurations with one channel are obtained taking into consideration the CH1:A1 input only. In this case it is necessary to consider time t_R referred to input CH1:A1, time t_A referred to input CH1:A1 and to the start, and time t_{MIN} referred to the start.

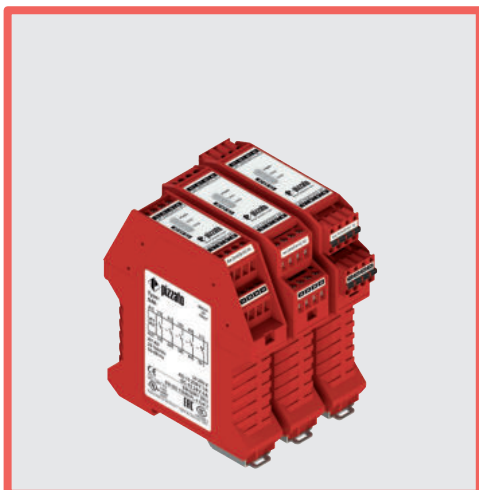

Module for emergency stops and end position monitoring for movable guards

Main features

- For safety applications up to SIL CL 3/PL e
- Input with 1 or 2 channels
- Choice between automatic start, manual start (CS AR-24 only) or monitored start (CS AR-25 only)
- Reduced housing width of 22.5 mm
- 4 NO safety contacts
- 1 NC auxiliary contact
- Supply voltage: 24 Vac/dc

Utilization categories

Alternating current: AC15 (50...60 Hz)

U_e (V) 230

I_e (A) 3

Direct current: DC13 (6 oper. cycles/min.)

U_e (V) 24

I_e (A) 4

Quality marks:



EC type examination certificate: IMQ CP 432 DM

UL approval: E131787

CCC approval: 2020970305002290

EAC approval: RU C-IT.YT03.B.00035/19

Compliance with the requirements of:

Machinery Directive 2006/42/EC,

EMC Directive 2014/30/EC,

RoHS Directive 2011/65/EU.

Technical data

Housing

Polyamide housing PA 66, self-extinguishing V0 acc. to UL 94

Protection degree acc. to EN 60529:

IP40 (housing), IP20 (terminal strip)

Dimensions:

see page 355, design A

General data

SIL level (SIL CL) up to:

SIL CL 3 acc. to EN 62061

Performance Level (PL) up to:

PL e acc. to EN ISO 13849-1

Safety category up to:

cat. 3 acc. to EN ISO 13849-1

Safety parameters:

see page 417

Ambient temperature:

-25°C...+55°C

Mechanical endurance:

>10 million operating cycles

Electrical endurance:

>100,000 operating cycles

Pollution degree:

external 3, internal 2

Rated impulse withstand voltage (U_{imp}):

4 kV

Rated insulation voltage (U_i):

250 V

Overvoltage category:

II

Supply

Rated supply voltage (U_n):

24 Vac/dc; 50...60 Hz

Max. DC residual ripple in DC:

10%

Supply voltage tolerance:

±15% of U_n

Power consumption AC:

< 5 VA

Power consumption DC:

< 2 W

Control circuit

Protection against short circuits:

PTC resistance, I_h=0.5 A

PTC times:

response time > 100 ms, release time > 3 s

Maximum resistance per input:

≤ 50 Ω

Current per input:

30 mA (typical)

Min. duration of start impulse t_{MIN}:

> 100 ms

Response time t_A:

< 85 ms

Release time t_{R1}:

< 40 ms

Release time in absence of power supply t_{R2}:

< 170 ms

Simultaneity time t_c:

unlimited

In compliance with standards:

EN 60204-1, EN ISO 13855, EN ISO 14118, EN ISO 12100, EN ISO 13850, EN 60529, EN 61000-6-2, EN 61000-6-3, EN 61326-1, EN 60664-1, EN 60947-1, EN IEC 63000, EN ISO 13849-1, EN ISO 13849-2, EN 62061, UL 508, CSA C22.2 n° 14-95, GB/T14048.5

Output circuit

Output contacts:

4 NO safety contacts

1 NC auxiliary contact

forcibly guided

gold-plated silver alloy

230/240 Vac; 300 Vdc

Contact type:

Material of the contacts:

Maximum switching voltage:

Max. current per contact:

Conventional free air thermal current I_{th}:

Max. total current Σ I_{th}²:

Minimum current:

Contact resistance:

External protection fuse:

6 A

6 A

72 A²

10 mA

≤ 100 mΩ

4 A

The number and the load capacity of output contacts can be increased by using expansion modules or contactors. See pages 295-304.

Code structure

CS AR-24V024

Start mode

24 manual or automatic start

25 monitored start

Supply voltage

024 24 Vac/dc

Connection type

V Screw terminals

M Connector with screw terminals

X Connector with spring terminals

Features approved by UL

Rated supply voltage (U_n): 24 Vac/dc; 50...60 Hz

Power consumption AC: < 5 VA

Power consumption DC: < 4 W

Electrical ratings: 230/240 Vac

6 A general use

C300 pilot duty

Notes:

- Use 60 or 75°C copper (Cu) conductor and wire size No. 30-12 AWG, stranded or solid.

- The terminal tightening torque of 5-7 lb in.

- Only for 24 Vac/dc versions: supply from remote Class 2 source or limited voltage limited energy.



Safety module CS AR-24 / CS AR-25

Pin assignment

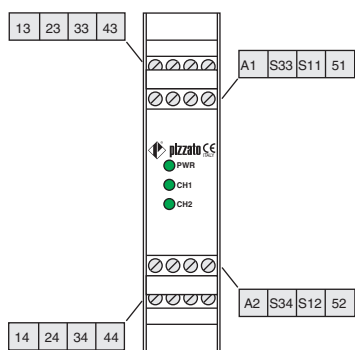

Function diagrams

Configuration with automatic start (CS AR-24 only)

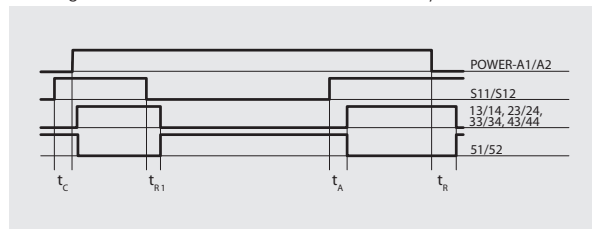

Configuration with monitored start (CS AR-25 only)

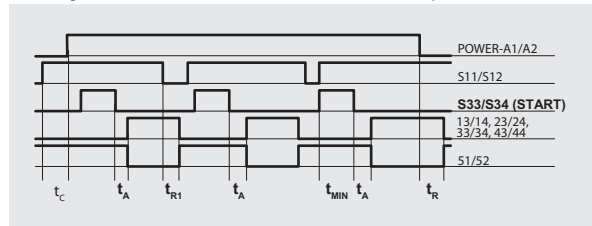

Internal block diagram

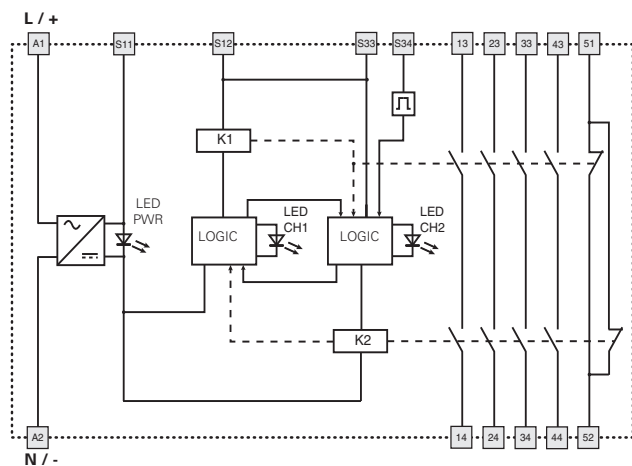

Configuration with manual start (CS AR-24 only)

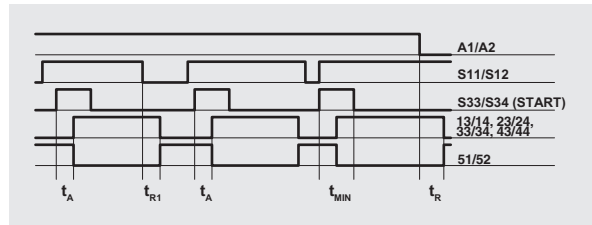

- Legend:
- t_{MIN} : Min. duration of start impulse
 - t_c : simultaneity time
 - t_A : response time
 - t_r : release time
 - t_{r1} : release time in absence of power supply

Notes:
 The configurations with one channel are obtained taking into consideration the S11/S12 input only. In this case it is necessary to consider time t_{r1} referred to input S11/S12, time t_r referred to the supply, time t_A referred to input S11/S12 and to the start, and time t_{MIN} referred to the start.

Input configuration

Emergency stop circuits	
Input configuration with manual start	
1 channel	2 channels

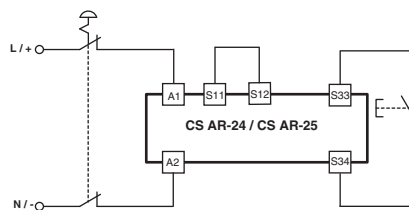
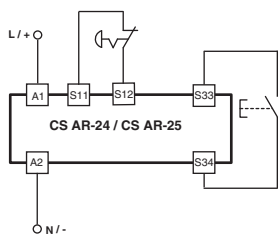

The diagram does not show the exact position of the terminals in the product

Automatic start

With regard to the indicated diagrams, bridge the start button between S33 and S34 in order to activate the automatic start module.

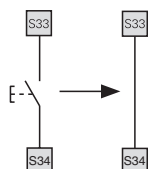

Monitored start

Use module CS AR-25 with the circuit diagrams for manual start.

Movable guard monitoring

The safety module can monitor emergency stop circuits and control circuits for movable guards. Replace the emergency stop contacts with the switch contacts.

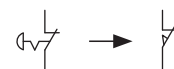

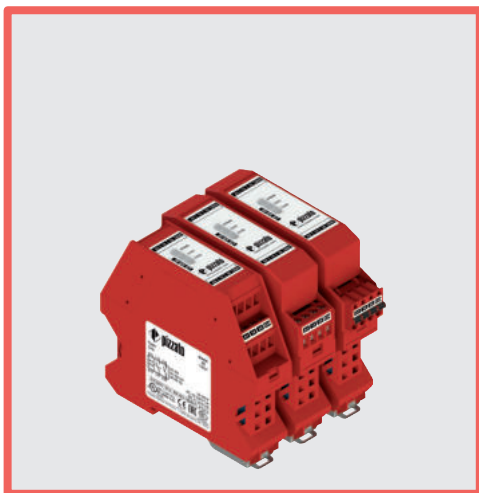

Module for emergency stops and end position monitoring for movable guards

Main features

- For safety applications up to SIL CL 2/PL d
- Choice between automatic start, manual start (CS AR-40 only) or monitored start (CS AR-41 only)
- Reduced housing width of 22.5 mm
- 2 NO safety contacts
- Supply voltage: 24 Vac/dc

Utilization categories

Alternating current: AC15 (50...60 Hz)

U_e (V) 230

I_e (A) 3

Direct current: DC13 (6 oper. cycles/min.)

U_e (V) 24

I_e (A) 4

Quality marks:



EC type examination certificate: IMQ CP 432 DM

UL approval: E131787

CCC approval: 2020970305002290

EAC approval: RU C-IT.YT03.B.00035/19

Compliance with the requirements of:

Machinery Directive 2006/42/EC,

EMC Directive 2014/30/EC,

RoHS Directive 2011/65/EU.

Technical data

Housing

Polyamide housing PA 66, self-extinguishing V0 acc. to UL 94

Protection degree acc. to EN 60529:

IP40 (housing), IP20 (terminal strip)

Dimensions:

see page 355, design D

General data

SIL level (SIL CL) up to:

SIL CL 2 acc. to EN 62061

Performance Level (PL) up to:

PL d acc. to EN ISO 13849-1

Safety category up to:

cat. 2 acc. to EN ISO 13849-1

Safety parameters:

see page 417

Ambient temperature:

-25°C...+55°C

Mechanical endurance:

>10 million operating cycles

Electrical endurance:

>100,000 operating cycles

Pollution degree:

external 3, internal 2

Rated impulse withstand voltage (U_{imp}):

4 kV

Rated insulation voltage (U_i):

250 V

Overvoltage category:

II

Supply

Rated supply voltage (U_n):

24 Vac/dc; 50...60 Hz

Max. DC residual ripple in DC:

10%

Supply voltage tolerance:

±15% of U_n

Power consumption AC:

< 5 VA

Power consumption DC:

< 2 W

Control circuit

Protection against short circuits:

PTC resistance, I_h=0.5 A

PTC times:

response time > 100 ms, release time > 3 s

Maximum resistance per input:

≤ 50 Ω

Current per input:

70 mA (typical)

Min. duration of start impulse t_{MIN}:

> 100 ms

Response time t_A:

< 50 ms

Release time in absence of power supply t_R:

< 105 ms

Simultaneity time t_C:

unlimited

In compliance with standards:

EN 60204-1, EN ISO 13855, EN ISO 14118, EN ISO 12100, EN ISO 13850, EN 60529, EN 61000-6-2, EN 61000-6-3, EN 61326-1, EN 60664-1, EN 60947-1, EN IEC 63000, EN ISO 13849-1, EN ISO 13849-2, EN 62061, UL 508, CSA C22.2 n° 14-95, GB/T14048.5

Output circuit

Output contacts:

2 NO safety contacts

Contact type:

forcibly guided

Material of the contacts:

silver alloy

Maximum switching voltage:

230/240 Vac; 300 Vdc

Max. current per contact:

6 A

Conventional free air thermal current I_{th}:

6 A

Max. total current Σ I_{th}²:

36 A²

Minimum current:

10 mA

Contact resistance:

≤ 100 mΩ

External protection fuse:

4 A

The number and the load capacity of output contacts can be increased by using expansion modules or contactors. See pages 295-304.

Code structure

CS AR-40V024

Start mode

40 manual or automatic start

41 monitored start

Supply voltage

024 24 Vac/dc

Connection type

V Screw terminals

M Connector with screw terminals

X Connector with spring terminals

Features approved by UL

Rated supply voltage (U_n): 24 Vac/dc; 50...60 Hz

Power consumption AC: < 5 VA

Power consumption DC: < 4 W

Electrical ratings: 230/240 Vac

6 A general use

C300 pilot duty

Notes:

- Use 60 or 75°C copper (Cu) conductor and wire size No. 30-12 AWG, stranded or solid.

- The terminal tightening torque of 5-7 lb in.

- Only for 24 Vac/dc versions: supply from remote Class 2 source or limited voltage limited energy.



Safety module CS AR-40 / CS AR-41

Pin assignment

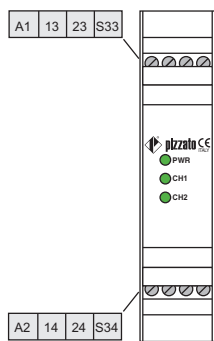

Internal block diagram

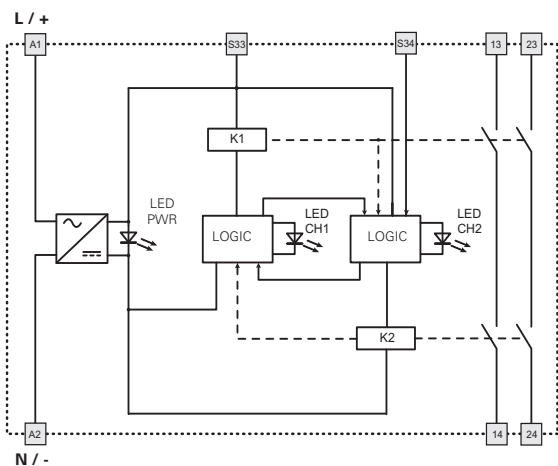

Function diagrams

1-channel configuration with automatic start (CS AR-40 only)

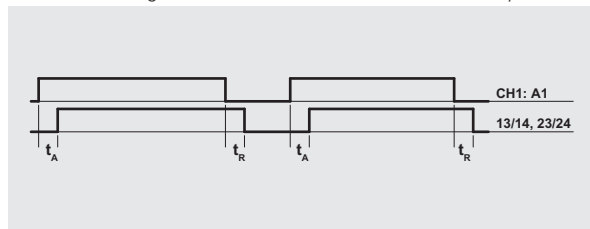

1-channel configuration with manual start (CS AR-40 only)

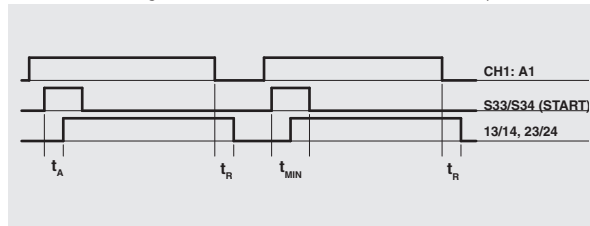

1-channel configuration with monitored start (CS AR-41 only)

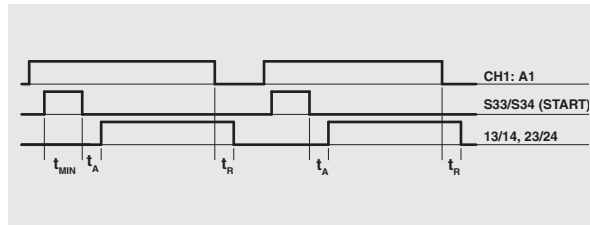

Legend:
t_MIN: Min. duration of start impulse
t_A: response time
t_R: release time in absence of power supply

Input configuration

Emergency stop circuits
One channel input configuration with manual start

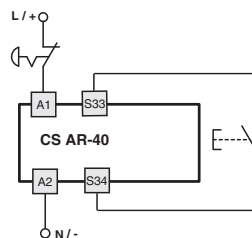

The diagram does not show the exact position of the terminals in the product

Automatic start

With regard to the indicated diagram, bridge the start button between S33 and S34 in order to activate the automatic start module.

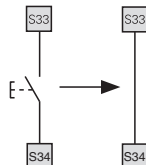

Monitored start

Use module CS AR-41 with the circuit diagrams for manual start.

Movable guard monitoring

The safety module can monitor emergency stop circuits and control circuits for movable guards. Replace the emergency stop contacts with the switch contacts.

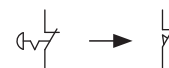

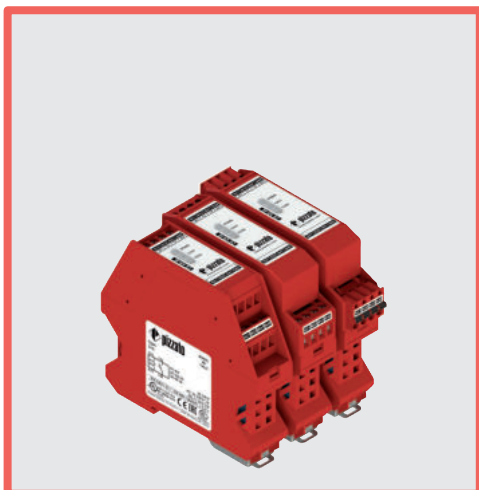

Module for emergency stop, end position monitoring for movable guards, and magnetic safety sensors and devices

Main features

- For safety applications up to SIL CL 1/PL c
- Reduced housing width of 22.5 mm
- 1 NO safety contact
- Supply voltage: 24 Vac/dc

Utilization categories

Alternating current: AC15 (50...60 Hz)

U_e (V) 230

I_e (A) 3

Direct current: DC13 (6 oper. cycles/min.)

U_e (V) 24

I_e (A) 4

Quality marks:



UL approval: E131787

CCC approval: 2020970305002290

EAC approval: RU C-IT.YT03.B.00035/19

Compliance with the requirements of:

Machinery Directive 2006/42/EC,

EMC Directive 2014/30/EC,

RoHS Directive 2011/65/EU.

Technical data

Housing

Polyamide housing PA 66, self-extinguishing V0 acc. to UL 94

Protection degree acc. to EN 60529:

IP40 (housing), IP20 (terminal strip)

Dimensions:

see page 355, design D

General data

SIL level (SIL CL) up to:

SIL CL 1 acc. to EN 62061

Performance Level (PL) up to:

PL c acc. to EN ISO 13849-1

Safety category up to:

cat. 1 acc. to EN ISO 13849-1

Safety parameters:

see page 417

Ambient temperature:

-25°C...+55°C

Mechanical endurance:

>10 million operating cycles

Electrical endurance:

>100,000 operating cycles

Pollution degree:

external 3, internal 2

Rated impulse withstand voltage (U_{imp}):

4 kV

Rated insulation voltage (U_i):

250 V

Overtoltage category:

II

Supply

Rated supply voltage (U_n):

24 Vac/dc; 50...60 Hz

Max. DC residual ripple in DC:

10%

Supply voltage tolerance:

±15% of U_n

Power consumption AC:

< 5 VA

Power consumption DC:

< 2 W

Control circuit

Protection against short circuits:

PTC resistance, I_h=0.5 A

PTC times:

response time > 100 ms, release time > 3 s

Maximum resistance per input:

≤ 50 Ω

Current per input:

20 mA (typical)

Response time t_A:

< 15 ms

Release time t_{R1}:

< 20 ms

Release time in absence of power supply t_R:

< 100 ms

Simultaneity time t_C:

unlimited

In compliance with standards:

EN 60204-1, EN ISO 13855, EN ISO 14118, EN ISO 12100, EN ISO 13850, EN 60529, EN 61000-6-2, EN 61000-6-3, EN 61326-1, EN 60664-1, EN 60947-1, EN IEC 63000, EN ISO 13849-1, EN ISO 13849-2, EN 62061, UL 508, CSA C22.2 n° 14-95, GB/T14048.5

Output circuit

Output contacts:

1 NO safety contact

Material of the contacts:

silver alloy

Maximum switching voltage:

230/240 Vac; 300 Vdc

Max. current per contact:

6 A

Conventional free air thermal current I_{th}:

6 A

Minimum current:

10 mA

Contact resistance:

≤ 100 mΩ

External protection fuse:

4 A

The number and the load capacity of output contacts can be increased by using expansion modules or contactors. See pages 295-304.

Code structure

CS AR-46V024

Connection type

V	Screw terminals
M	Connector with screw terminals
X	Connector with spring terminals

Supply voltage

024 24 Vac/dc

Features approved by UL

Rated supply voltage (U _n):	24 Vac/dc; 50...60 Hz
Power consumption AC:	< 5 VA
Power consumption DC:	< 4 W
Electrical ratings:	230/240 Vac 6 A general use C300 pilot duty

Notes:

- Use 60 or 75°C copper (Cu) conductor and wire size No. 30-12 AWG, stranded or solid.
- The terminal tightening torque of 5-7 lb.in.
- Only for 24 Vac/dc versions: supply from remote Class 2 source or limited voltage limited energy.



Safety module CS AR-46

Pin assignment

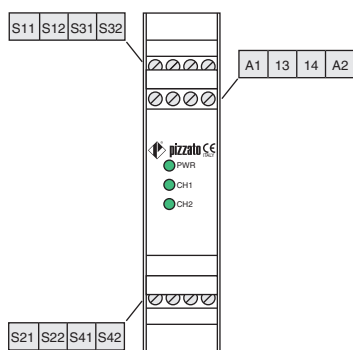

Function diagrams

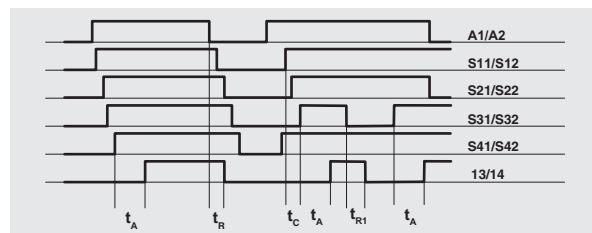

Legend:
 t_C : simultaneity time
 t_A : response time
 t_{R1} : release time
 t_A'' : release time in absence of power supply

Internal block diagram

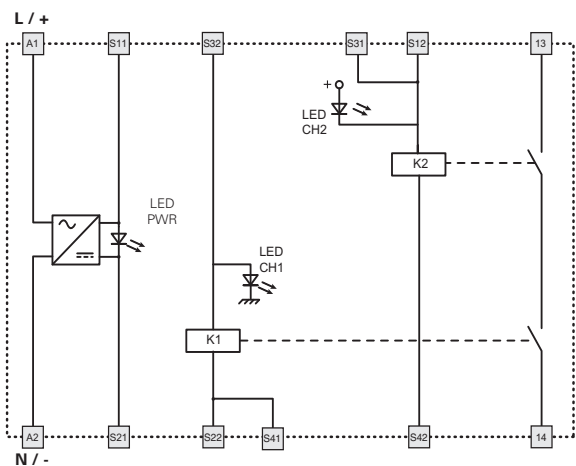

Input configuration

Emergency stop circuits		
Input configuration with automatic start		
2 channels and 1 emergency stop button	2 channels and 2 emergency stop buttons	2 channels and 4 switches

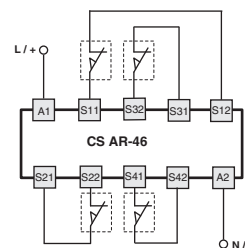
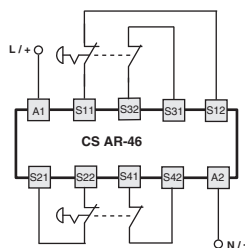
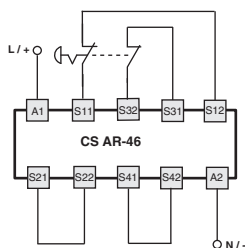

Monitoring of movable guards and magnetic safety sensors

The safety module can monitor emergency stop circuits, control circuits for movable guards as well as magnetic safety sensors. Replace the emergency stop contacts with switch contacts or sensor contacts. The sensors can only be used in 2-channel configuration.

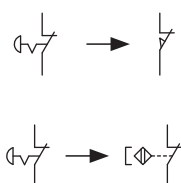

1 channel and 1 emergency stop button

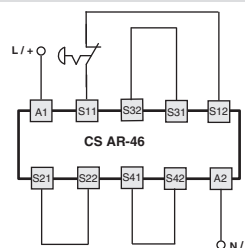

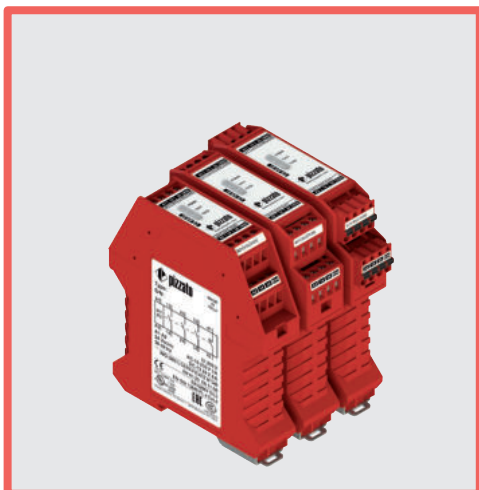

Module for emergency stops, end position monitoring for movable guards and magnetic safety sensors

Main features

- For safety applications up to SIL 3/PL e
- Choice between automatic start, manual start or monitored start
- Connection of input channels of opposite potentials
- Reduced housing width of 22.5 mm
- Output contacts:
2 NO safety contacts, 1 NO opto-decoupled auxiliary contact
- Supply voltage: 24 Vac/dc
- Insensitive to voltage dips

Utilization categories

Alternating current: AC15 (50...60 Hz)

U_e (V) 230

I_e (A) 3

Direct current: DC13 (6 oper. cycles/min.)

U_e (V) 24

I_e (A) 4

Quality marks:



EU-type examination certificate: IMQ n. 340

(EN 81-20:2014; EN 81-50:2014; EN 81-1:1998+A3:2009;

EN 81-2:1998+A3:2009)

EC type examination certificate: IMQ CP 432 DM

(Machinery Directive)

UL approval: E131787

CCC approval: 2020970305002290

EAC approval: RU C-IT.YT03.B.00035/19

Compliance with the requirements of:

Machinery Directive 2006/42/EC,

EMC Directive 2014/30/EC,

RoHS Directive 2011/65/EU,

Lifts Directive 2014/33/EU

Technical data

Housing

Polyamide housing PA 66, self-extinguishing V0 acc. to UL 94

Protection degree acc. to EN 60529:

IP40 (housing), IP20 (terminal strip)

Dimensions:

see page 355, design A

General data

SIL level (SIL CL) up to:

SIL CL 3 acc. to EN 62061

Performance Level (PL) up to:

PL e acc. to EN ISO 13849-1

Safety category up to:

cat. 4 acc. to EN ISO 13849-1

Safety parameters:

see page 417

Ambient temperature:

-25°C...+55°C

Mechanical endurance:

>10 million operating cycles

Electrical endurance:

>100,000 operating cycles

Pollution degree:

external 3, internal 2

Rated impulse withstand voltage (U_{imp}):

4 kV

Rated insulation voltage (U_i):

250 V

Overvoltage category:

II

Supply

Rated supply voltage (U_n):

24 Vac/dc; ±15%; 50...60 Hz

Max. DC residual ripple in DC:

10%

Power consumption AC:

< 5 VA

Power consumption DC:

< 2.5 W

Control circuit

Protection against short circuits:

PTC resistance, I_h=0.5 A

PTC response time:

response time > 100 ms, release time > 3 s

Maximum resistance per input:

≤ 50 Ω

Current per input:

< 40 mA

Min. duration of start impulse t_{MIN}:

> 50 ms

Response time t_A:

< 120 ms

Release time t_{R1}:

< 15 ms

Release time in absence of power supply t_R:

< 65 ms

Simultaneity time t_c:

unlimited

Response time starting from application of the supply:

< 300 ms

Auxiliary signalling circuit

Auxiliary output (Y43-Y44):

1 NO opto-decoupled

Rated operating voltage (U_e):

24 Vdc

Rated operating current (I_e):

25 mA

Rated impulse withstand voltage (U_{imp}):

4 kV

Release time t_{R2}:

< 1 ms

In compliance with standards:

EN 60204-1, EN ISO 13855, EN ISO 14118, EN ISO 12100, EN ISO 13850, EN 60529, EN 61000-6-2, EN 61000-6-3, EN 61326-1, EN 60664-1, EN 60947-1, EN IEC 63000, EN ISO 13849-1, EN ISO 13849-2, EN 62061, UL 508, CSA C22.2 n° 14-95, GB/T14048.5

Output circuit

Output contacts:

2 NO safety contacts,

Contact type:

forcibly guided

Material of the contacts:

gold-plated silver alloy

Maximum switching voltage:

230/240 Vac; 300 Vdc

Max. current per contact:

6 A

Conventional free air thermal current I_{th}:

6 A

Max. total current Σ I_{th}²:

36 A²

Minimum current:

10 mA

Contact resistance:

≤ 100 mΩ

External protection fuse:

4 A type F

The number and the load capacity of output contacts can be increased by using expansion modules or contactors. See pages 295-304.

Code structure

CS AR-91V024

Connection type

V	Screw terminals
M	Connector with screw terminals
X	Connector with spring terminals

Supply voltage

024 24 Vac/dc

Features approved by UL

Rated supply voltage (U _n):	24 Vac/dc; 50...60 Hz
Power consumption AC:	< 5 VA
Power consumption DC:	< 4 W
Electrical ratings:	230/240 Vac 6 A general use C300 pilot duty

Notes:

- Use 60 or 75°C copper (Cu) conductor and wire size No. 30-12 AWG, stranded or solid.
- The terminal tightening torque of 5-7 lb in.
- Only for 24 Vac/dc versions: supply from remote Class 2 source or limited voltage limited energy.



Safety module CS AR-91

Pin assignment

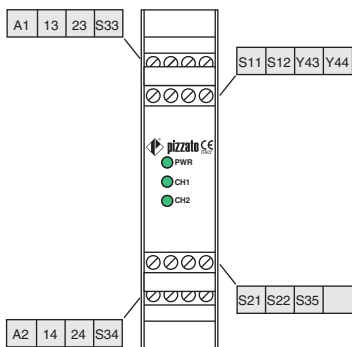

Voltage dips, short interruptions and voltage variations

The CS AR-91 safety module has a built-in voltage drop sensor which serves to protect and safeguard the internal state of the safety relays, in the event of dips or short voltage interruptions. This is to prevent unwanted switching states in relation to the state of the inputs from occurring. When voltage is restored, the device continues to operate with a switching state that is consistent with the input signals. The safety module retains its normal function during voltage dips and brief interruptions; for longer voltage interruptions, the safety outputs open and reset themselves automatically during an automatic start if voltage is restored or – in the case of a manual or monitored start – require that the system be reset by the operator.

Function diagrams

Configuration with automatic start

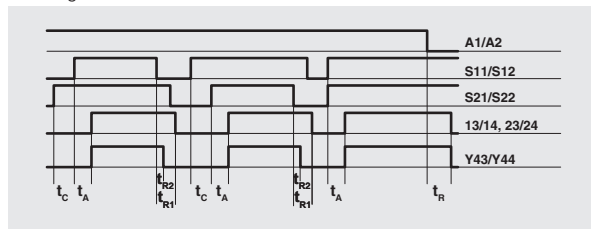

Configuration with monitored start

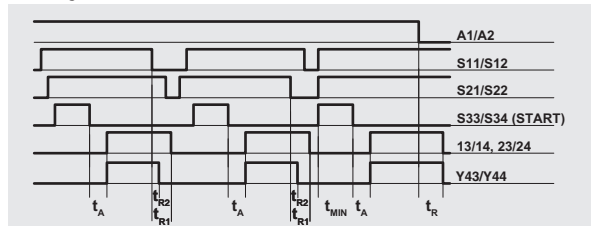

Configuration with manual start

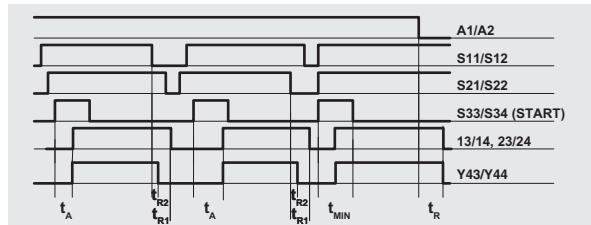

Legend:
 t_{MIN} : Min. duration of start impulse
 t_{c} : simultaneity time
 t_A : response time
 t_{R1} : release time
 t_{R2} : release time in absence of power supply

Notes:
 The configurations with one channel are obtained taking into consideration the S11/ S12 input only. In this case it is necessary to consider time t_{R1} referred to input S11/S12, time t_R referred to the supply, time t_A referred to input S11/S12 and to the start, and time t_{MIN} referred to the start.

Internal block diagram

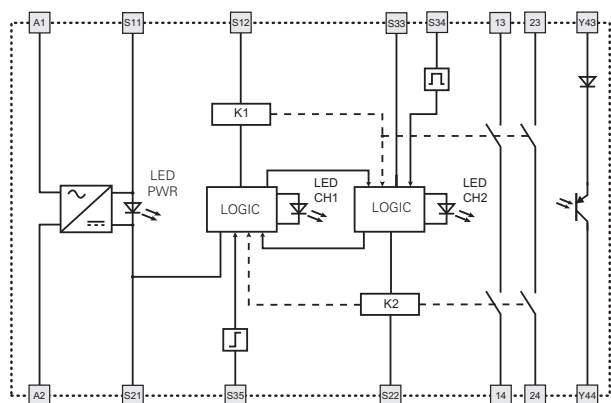

Input configuration

Input configuration with magnetic sensors

2 channels

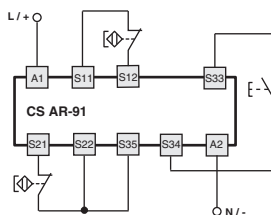

The diagram does not show the exact position of the terminals in the product

Automatic start

With regard to the indicated diagrams, bridge the start button between S33 and S34 in order to activate the automatic start module.

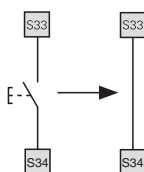

Monitored start

With regard to the indicated diagrams, remove the connection between the S22 and S35 terminals in order to activate the monitored start module.

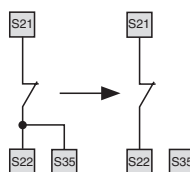

Monitoring of movable guards and magnetic safety sensors

The safety module can monitor emergency stop circuits, control circuits for movable guards as well as magnetic safety sensors. Replace the emergency stop contacts with switch contacts or sensor contacts. The sensors can only be used in 2-channel configuration.

