

Selection diagram

INTERNAL CONTACTS



ACTUATORS



DS KA1A

straight fixing
18 mm length

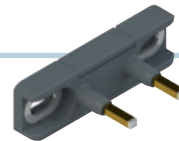

DS KA2A

straight fixing
21 mm length

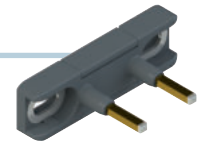

DS KA3A

straight fixing
23 mm length



DS KB1A

90-degree fixing
18 mm length



DS KB2A

90-degree fixing
21 mm length



DS KB3A

90-degree fixing
23 mm length

BODY DESIGN



DS AA1VA

Dimensions 50 x 30 x 15,5 mm



DS AE1VA

Dimensions 50 x 30 x 18,5 mm

EXTERNAL CONTACTS



ACTUATOR

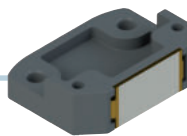

DS KP5A

90-degree fixing
flat contact

BODY DESIGN



DS AA5VA

Dimensions 50 x 30 x 15,5 mm



DS AE5VA

Dimensions 50 x 30 x 18,5 mm

- product options
- sold separately as accessory

**Code structure for door contacts****Attention!** The feasibility of a code number does not mean the effective availability of a product. Please contact our sales office.**DS AA1VA**

Body design		Contact type	
A	Dimensions 50 x 30 x 15,5 mm mounting hole spacing 40 mm fixing with M4x10 screws	1	internal contacts
E	Dimensions 50 x 30 x 18,5 mm mounting hole spacing 40 mm fixing with M4x13 screws	5	external contacts

Code structure for actuator**Attention!** The feasibility of a code number does not mean the effective availability of a product. Please contact our sales office.**DS KA1A**

Body design		Contact type	
A	Mounting hole spacing 29 mm straight fixing	1	actuator for internal contacts, 18 mm length
B	Mounting hole spacing 20 mm 90-degree fixing	2	actuator for internal contacts, 21 mm length
P	Mounting hole spacing 30 mm 90-degree fixing, flat contact	3	actuator for internal contacts, 23 mm length
		5	actuator for external contacts, 12 x 20 mm



Main features

- Housing made of glass fibre reinforced technopolymer, self-extinguishing
- Self-cleaning contacts in solid silver
- Can be installed with cable side flush with wall
- Front actuation
- Protection degrees IP00 up to IP20
- Transparent cover or head

Quality marks:



UL approval:	E131787
CCC approval:	2013010305602310
EAC approval:	RU C-IT.YT03.B.00035/19

Technical data

Description

Double interruption positive opening safety switch. Suitable for controlling automatic lift doors.

Housing

Housing made of glass fiber reinforced technopolymer, self-extinguishing and shock-proof
 Protection degree acc. to EN 60529: IP00 (articles DS A•5VA)
 IP20 (articles DS A•1VA)

General data

Ambient temperature:	-30°C ... +80°C (humidity ≤ 95%, without condensation)
Max. operating frequency:	3600 operating cycles/hour
Mechanical endurance:	10 million operating cycles (DS A•1VA) 5 million operating cycles (DS A•5VA)
Mechanical interlock, not coded:	type 1 acc. to EN ISO 14119
Safety parameter B _{10D} :	20,000,000 (DS A•1VA) 10,000,000 (DS A•5VA)
Max. actuation speed:	0.5 m/s
Min. actuation speed:	1 mm/s
Actuating force:	1.2 ... 2.1 N (DS A•1VA) 1.2 ... 1.7 N (DS A•5VA)
Available with reduced actuating force on request:	0.8 ... 1.3 N (DS A•1VA) 0.8 ... 1.1 N (DS A•5VA)
Tightening torques for installation:	see page 144
Fixing screws:	M4 self-tapping Longer fixing screws available on request

Connections:

Cable cross section (flexible copper strands):	min. 1 x 0.5 mm ² (1 x AWG 20) max 1 x 2.5 mm ² (1 x AWG 14)
Cable stripping length:	7 mm

In compliance with standards:

IEC 60947-5-1, EN 60947-5-1, EN 60947-1, EN 60529, EN ISO 14119, EN 60529, EN IEC 63000, EN 81-20, EN 81-50, UL 508, CSA 22.2 No.14.

Approvals:

IEC 60947-5-1, UL 508, CSA 22.2 No.14, GB/T14048.5-2017.

Compliance with the requirements of:

Low Voltage Directive 2014/35/EU, EMC Directive 2014/30/EU,
 Lift Directive 2014/33/EU, RoHS Directive 2011/65/EU.

Positive contact opening in conformity with standards:

IEC 60947-5-1, EN 60947-5-1.

Electrical data

Thermal current (I _{th}):	4 A
Rated insulation voltage (U _i):	500 Vac
Impulse withstand voltage (U _{imp}):	6 kV
Protection against short circuits:	type gG fuse 4 A 500 V
Pollution degree:	3

Utilization categories:

Acc. to	Acc. to	Acc. to
EN 60947-5-1, EN 81-20 par. 5.11.2.2	EN 81-50 par. 5.2.2.4	EN 81-50 par. 5.2.2.2
AC15 (50, 60 Hz):	AC (50, 60 Hz):	AC (50, 60 Hz):
U _e (V) 120 250	230 Vac	230 Vac
I _e (A) 3 3	2 A	2 A
DC13:	DC:	DC:
U _e (V) 125 250	200 Vdc	125 Vdc
I _e (A) 0,55 0,27	2 A	0.5 A

Application examples

These devices have additional cable outlets, allowing installation even in tight spaces. For example:

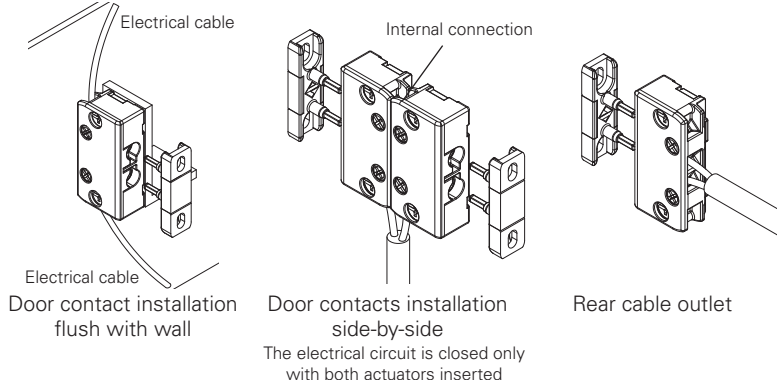

Features approved by UL

Electrical Ratings: Q300 (69 VA, 125-250 V dc)
 120-240 V ac, 3 A pilot duty,
 5 A thermal current.

Use 60 or 75°C copper (Cu) conductors, rigid or flexible, wire size 12, 14 AWG. Tightening torque for terminal screws of 7.1 lb in (0.8 Nm).

Please contact our technical department for the list of approved products.

Dimensional drawings

 Packs of **10 pcs.**

	Door contacts with internal contacts		Door contacts with external contacts	
	Switch without actuator	Switch without actuator	Switch without actuator	Switch without actuator
Slow action contacts	DS AA1VA 1NC	DS AE1VA 1NC	DS AA5VA 1NC	DS AE5VA 1NC
Maximum actuation travel	8 mm	8 mm	6 mm	6 mm
Travel diagram				

Legend

Closed contact | Open contact | Positive opening travel | Minimum 2 mm opening travel between contacts, in accordance with UNI EN 81-20

Actuators for door contacts with internal contacts

 Packs of **10 pcs.**

Article	Description
DS KA1A	Straight actuator
DS KA2A	Straight actuator (*)
DS KA3A	Straight actuator (*)

Article	Description
DS KB1A	Angled actuator
DS KB2A	Angled actuator (*)
DS KB3A	Angled actuator (*)

 (*) **ATTENTION:** When inserting the actuator, never exceed the maximum actuating travel.

Actuator for door contacts with external contacts

 Packs of **10 pcs.**

Article	Description
DS KP5A	Flat actuator

Centring device

 Packs of **100 pcs.**

Article	Description
VD CE1A20	Centring device

Centring device compatible with DS KA•• and DS KB•• actuators. Facilitates actuator centring with DS A•1VA switches during installation.

All values in the drawings are in mm

Accessories See page 135

 → The 2D and 3D files are available at www.pizzato.com

Selection diagram

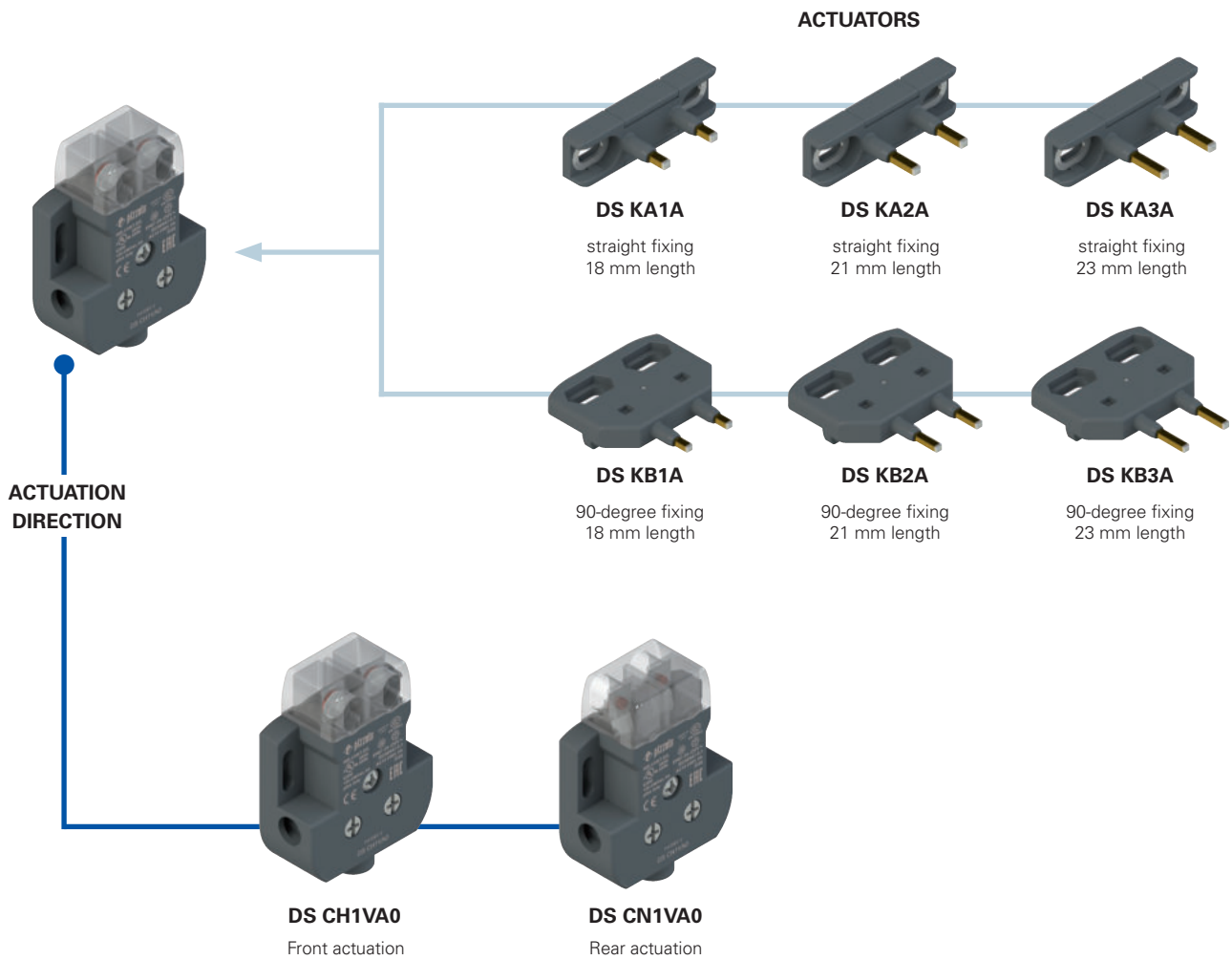

—●— product options
—→— sold separately as accessory

**Code structure for switch****Attention!** The feasibility of a code number does not mean the effective availability of a product. Please contact our sales office.**DS CH1VA0**

Actuation direction	
H	Front actuation Dimensions 60 x 44 x 19 mm
N	Rear actuation Dimensions 60 x 44 x 19 mm

Code structure for actuator**Attention!** The feasibility of a code number does not mean the effective availability of a product. Please contact our sales office.**DS KA1A**

Body design		Contact type	
A	Mounting hole spacing 29 mm straight fixing	1	actuator for internal contacts, 18 mm length
B	Mounting hole spacing 20 mm 90-degree fixing	2	actuator for internal contacts, 21 mm length
		3	actuator for internal contacts, 23 mm length

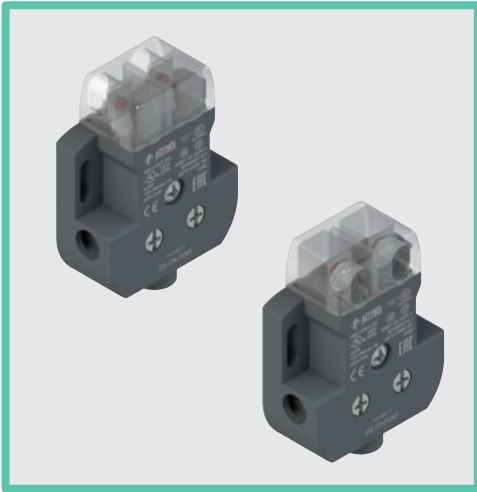

Main features

- Housing made of glass fibre reinforced technopolymer, self-extinguishing
- Self-cleaning contacts in solid silver
- 3 wiring options
- Protection degree IP20
- Transparent orientable head

Quality marks:



UL approval: E131787
 CCC approval: 2013010305602310
 EAC approval: RU C-IT.YT03.B.00035/19

Technical data

Description

Double interruption positive opening safety switch. Suitable for controlling automatic lift doors.

Housing

Housing made of glass fiber reinforced technopolymer, self-extinguishing and shock-proof
 Protection degree acc. to EN 60529: IP20

General data

Ambient temperature: -30°C ... +80°C
 (humidity ≤ 95%, without condensation)
 Max. operating frequency: 3600 operating cycles/hour
 Mechanical endurance: 20 million operating cycles
 Mechanical interlock, not coded: type 1 acc. to EN ISO 14119
 Safety parameter B_{10D} : 40,000,000 for NC contacts
 Max. actuation speed: 0.5 m/s
 Min. actuation speed: 1 mm/s
 Max. actuating force: 1.5 N
 Tightening torques for installation: see page 144

Connections:

Cable cross section (flexible copper strands): min. 1 x 0.5 mm² (1 x AWG 20)
 max 1 x 2.5 mm² (1 x AWG 14)
 Cable stripping length: 7 mm

In compliance with standards:

IEC 60947-5-1, EN 60947-5-1, EN 60947-1, EN 60529, EN ISO 14119, EN 60529, EN IEC 63000, EN 81-20, EN 81-50, UL 508, CSA 22.2 No.14.

Approvals:

IEC 60947-5-1, UL 508, CSA 22.2 No.14, GB/T14048.5-2017.

Compliance with the requirements of:

Low Voltage Directive 2014/35/EU, EMC Directive 2014/30/EU,
 Lift Directive 2014/33/EU, RoHS Directive 2011/65/EU.

Positive contact opening in conformity with standards:

IEC 60947-5-1, EN 60947-5-1.

Electrical data

Thermal current (I_{th}): 6 A
 Rated insulation voltage (U_i): 500 Vac
 Impulse withstand voltage (U_{imp}): 6 kV
 Protection against short circuits: type gG fuse
 6 A 500 V
 Pollution degree: 3

Utilization categories:

Acc. to	Acc. to	Acc. to	Ratings:
EN 60947-5-1,	EN 81-50	EN 81-50	Acc. to
EN 81-20 par. 5.11.2.2	par. 5.2.2.4	par. 5.2.2.2	UL508
AC15 (50, 60 Hz):	AC (50, 60 Hz):	AC (50, 60 Hz):	AC (50, 60 Hz):
U_e (V) 120 250	230 Vac	230 Vdc	AC (50, 60 Hz):
I_e (A) 3 3	2 A	2 A	C300
DC13:	DC:	DC:	DC:
U_e (V) 125 250	200 Vdc	125 Vdc	Q300
I_e (A) 0.8 0.45	2 A	1 A	

Three wiring options

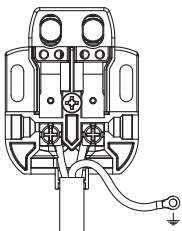

Standard wiring

With bipolar cable through the centre hole, on the bottom of the housing. It is also possible to use a tripolar cable, with the ground wire exiting via a lateral hole to earth other metallic parts.

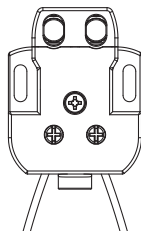

Fast bottom wiring

With two monopolar cables fed through two holes provided on the bottom of the housing. There is no need to open the contact cover during this procedure.

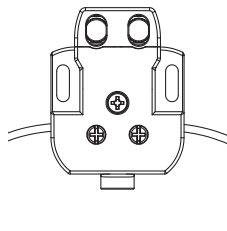

Fast lateral wiring

With two monopolar cables fed through two holes provided on the side of the housing. There is no need to open the contact cover during this procedure.

Transparent head and slotted holes

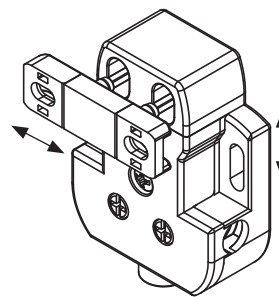

Head transparent on all sides, to allow adjustment and centering of the actuator in relation to contacts.

The slotted holes on the actuator and in the contact housing allow for correct alignment of both devices.



Rotating head

Turning the head and contact springs by 180°, a door contact with rear actuation can be converted to front actuation. Simply by loosening three screws.

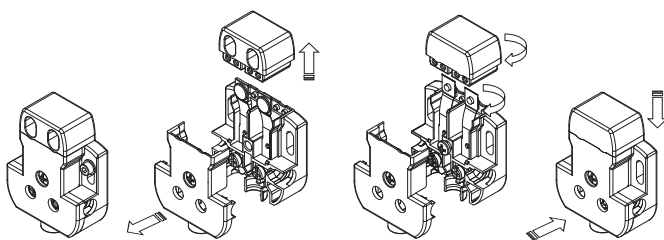

Rear fixing of the housing

The special housing shape allows rear fixing.

You also have the option of inserting a tubular wrench close to the mounting holes, to hold the nut in place during fixing.

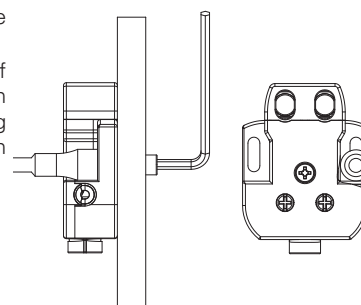

Dimensional drawings

Packs of 10 pcs.

	Front actuation Switch without actuator A= Actuator insertion direction	Rear actuation Switch without actuator A= Actuator insertion direction
Slow action contacts	DS CH1VA0 \odot 1NC	DS CN1VA0 \odot 1NC
Maximum actuation travel	6 mm	6 mm
Travel diagram		

Legend

■ Closed contact | □ Open contact | ⊕ Positive opening travel | ⊖ Minimum 2 mm opening travel between contacts, in accordance with UNI EN 81-20

Centring device

Packs of 100 pcs.

Article	Description
VD CE1A20	Centring device

Centring device compatible with DS KA●● and DS KB●● actuators. Facilitates actuator centring with DS C●1VA switches during installation.

Actuators

Packs of 10 pcs.

Article	Description
DS KA1A	Straight actuator

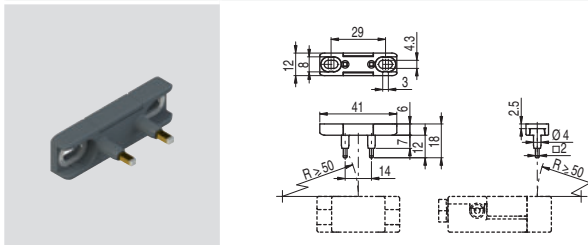

Article	Description
DS KB1A	Angled actuator

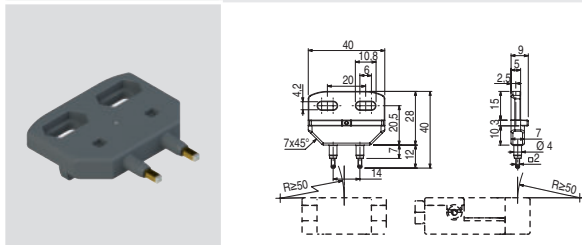

Article	Description
DS KA2A	Straight actuator (*)

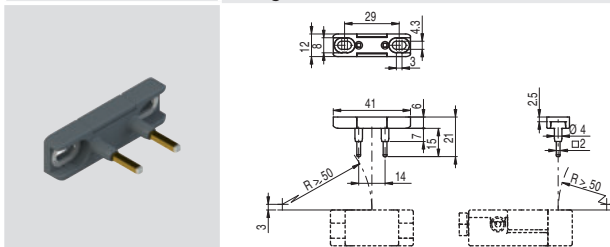

Article	Description
DS KB2A	Angled actuator (*)

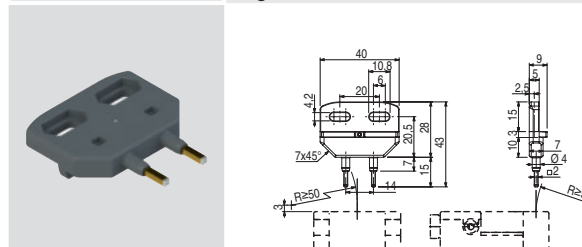

Article	Description
DS KA3A	Straight actuator (*)

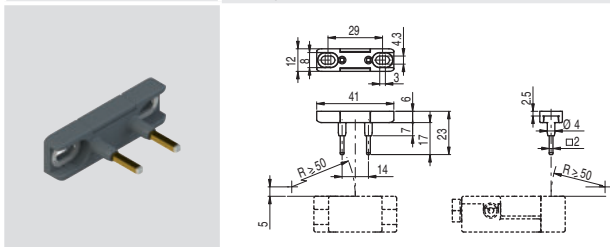

Article	Description
DS KB3A	Angled actuator (*)

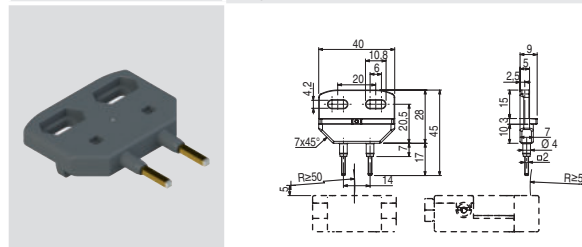

(*) **ATTENTION:** When inserting the actuator, never exceed the maximum actuating travel.

All values in the drawings are in mm

Accessories See page 135

→ The 2D and 3D files are available at www.pizzato.com

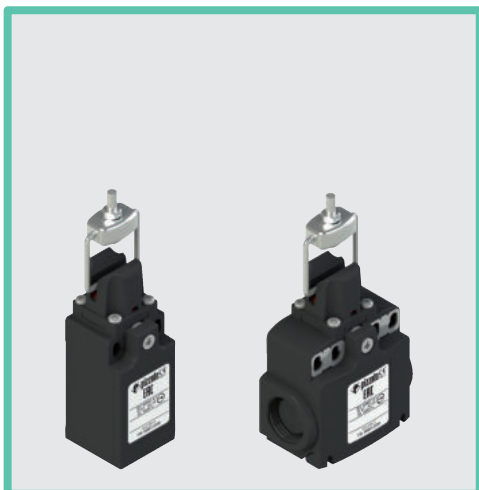

Main features

- Reduced actuating force
- Protection degree IP67
- Technopolymer housing, one or two conduit entries
- Ability to affix actuator in 2 positions, perpendicular to one another

Quality marks:



IMQ approval:	EG610
UL approval:	E131787
CCC approval:	2007010305230013
EAC approval:	RU C-IT.YT03.B.00035/19

Technical data

Description

Double interruption positive opening safety switch. Suitable for controlling automatic lift doors.

Housing

Housing made of glass fibre reinforced technopolymer, self-extinguishing, shock-proof and with double insulation: 

FR series, one conduit entry: M20x1.5 (M16x1.5 on request)

FX series, two knock-out threaded conduit entries: M20x1.5 (M16x1.5 on request)

Protection degree acc. to EN 60529: IP67 with cable gland of equal or higher protection degree

General data

Ambient temperature:	-25°C ... +80°C
Version for operation at ambient temperatures from -40°C ... +80°C on request	
Max. operating frequency:	3600 operating cycles/hour
Mechanical endurance:	10 million operating cycles
Mechanical interlock, not coded:	type 1 acc. to EN ISO 14119
Safety parameter B _{10D} :	20,000,000 for NC contacts
Max. actuation speed:	0.5 m/s
Min. actuation speed:	1 mm/s
Mounting position:	any
Tightening torques for installation:	see page 141
Wire cross-sections and wire stripping lengths:	see page 153

In compliance with standards:

IEC 60947-5-1, EN 60947-5-1, EN 60947-1, EN 50047, IEC 60204-1, EN 60204-1, EN ISO 14119, EN ISO 12100, IEC 60529, EN 60529, EN IEC 63000, EN 81-20, EN 81-50, UL 508, CSA 22.2 No.14.

Approvals:

IEC 60947-5-1, UL 508, CSA 22.2 No.14, GB/T14048.5-2017.

Compliance with the requirements of:

Low Voltage Directive 2014/35/EU, EMC Directive 2014/30/EU, Lift Directive 2014/33/EU, RoHS Directive 2011/65/EU.

Positive contact opening in conformity with standards:

IEC 60947-5-1, EN 60947-5-1.

Installation for safety applications:

Use only switches marked with the symbol  next to the product code. Always connect the safety circuit to the **NC contacts** (normally closed contacts: 11-12, 21-22 or 31-32) as stated in **standard EN 81-20 par. 5.11.2.2.1**. Actuate the switch **at least up to the positive opening travel** reported in the travel diagrams. Actuate the switch **at least with the positive opening force**, reported in brackets below each article, next to the actuating force value.

 **If not expressly indicated in this chapter, for correct installation and utilization of all articles see the instructions given on pages 139 to 146.**

Electrical data		Utilization category
Thermal current (I _{th}):	10 A	Alternating current: AC15 (50÷60 Hz)
Rated insulation voltage (U _i):	500 Vac 600 Vdc	U _e (V) 250 400 500
Rated impulse withstand voltage (U _{imp}):	6 kV	I _e (A) 6 4 1
Conditional short circuit current:	1000 A acc. to EN 60947-5-1	Direct current: DC13
Protection against short circuits:	type aM fuse 10 A 500 V	U _e (V) 24 125 250
Pollution degree:	3	I _e (A) 3 0.55 0.3

Features approved by IMQ

Rated insulation voltage (U _i):	500 Vac
Conventional free air thermal current (I _{th}):	10 A
Protection against short circuits:	type aM fuse 10 A 500 V
Rated impulse withstand voltage (U _{imp}):	6 kV
Protection degree of the housing:	IP67
MV terminals (screw terminals)	
Pollution degree:	3
Utilization category:	AC15
Operating voltage (U _e):	400 Vac (50 Hz)
Operating current (I _e):	3 A
Forms of the contact element: Y, Y+Y	
Positive opening of contacts on contact blocks 38, 39	
In compliance with standards: EN 60947-1, EN 60947-5-1, fundamental requirements of the Low Voltage Directive 2014/35/EU	

Please contact our technical department for the list of approved products.

Features approved by UL

Electrical Ratings:	Q300 pilot duty (69 VA, 125-250 V dc) A600 pilot duty (720 VA, 120-600 V ac)
Environmental Ratings:	Types 1, 4X, 12, 13
For all contact blocks use 60 or 75°C copper (Cu) conductors, rigid or flexible, wire size 12, 14 AWG. Tightening torque for terminal screws of 7.1 lb in (0.8 Nm).	
The hub is to be connected to the conduit before the hub is connected to the enclosure.	

Please contact our technical department for the list of approved products.

Dimensional drawings

Contact type:

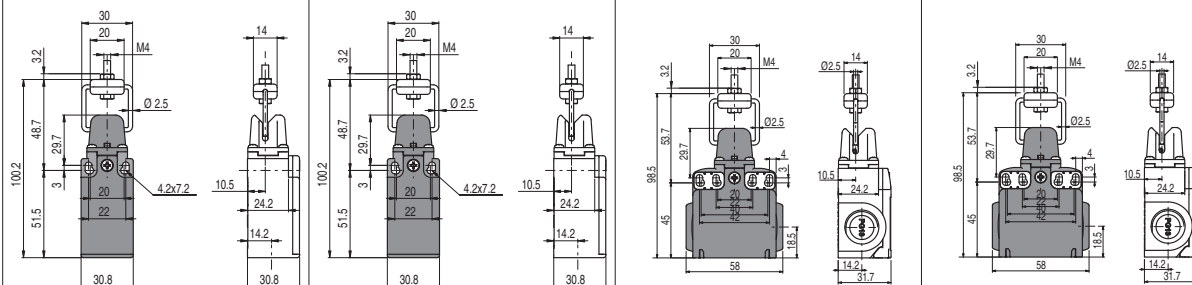
L = slow action

Contact blocks

38 L	FR 38B1-D30M2	/	FX 38B1-D30M2
39 L	/	FR 39B1-D30M2	FX 39B1-D30M2
Actuating force	3 N (25 N)	4.2 N (25 N)	4.2 N (25 N)
Travel diagrams			

Legend

Closed contact | Open contact | Positive opening travel

Compliant with EN 81-20 and EN 81-50

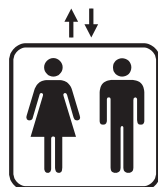

- Safety contacts in compliance with EN 60947-5-1, annex K.
- Protection degree higher than IP4x.
- Mechanical service life > 10⁶ cycles.

Adjustable actuator

The actuator can be fixed in two positions, perpendicular to one another. The switch can also be actuated from different directions.

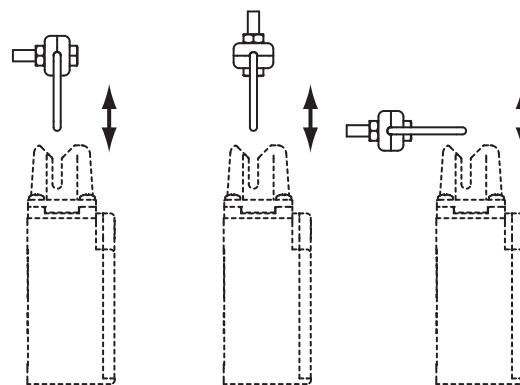

Separate actuator

Article	Description
VF KEYD30	Adjustable actuator

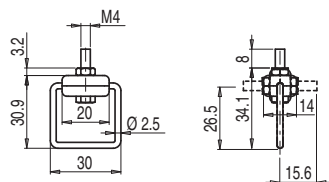

Head with variable orientation

The head of all switches is adjustable in 90° steps.

