

Accessories for rope installation - FAST line

Article	Description	Article	Description	Article	Description
VF AF-TR5	Adjustable stay bolt	VF AF-MR5	End clamp	VF AF-TR8	Stay bolt

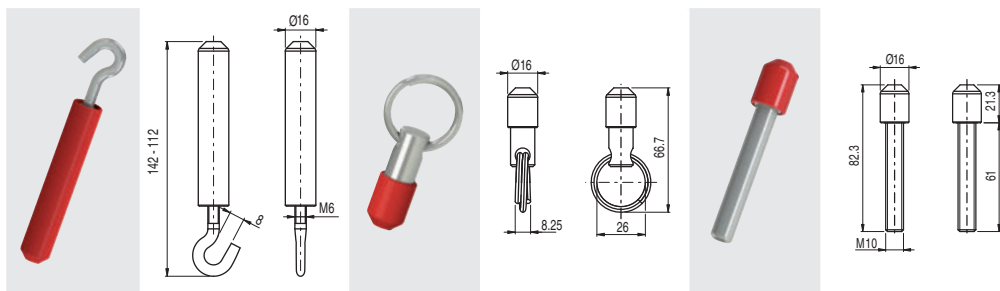

Accessories for rope installation

Article	Description	Article	Description	Article	Description	Article	Description
VF AF-TR2X	Adjustable stay bolt in stainless steel	VF T870	Stay bolt	VF M870	Terminal	VF C870	Jumper

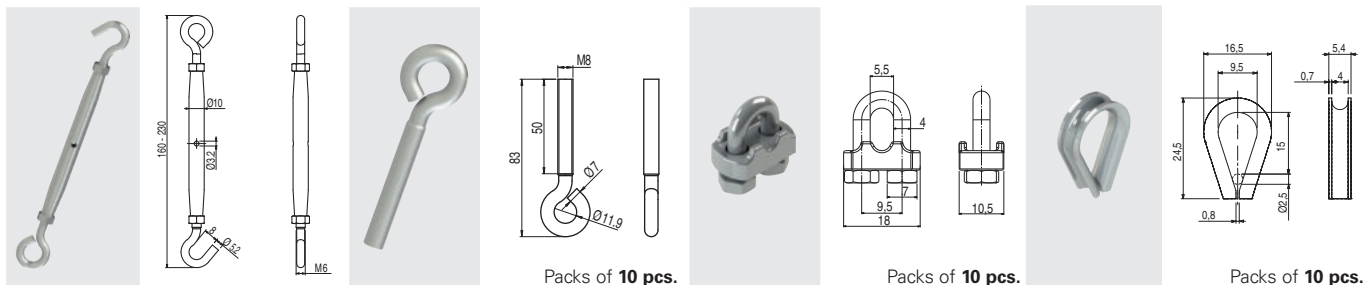

Pulleys

Article	Description	Article	Description
VF AF-CA5	Stainless steel pulley	VF AF-CA10	Angular pulley, stainless steel

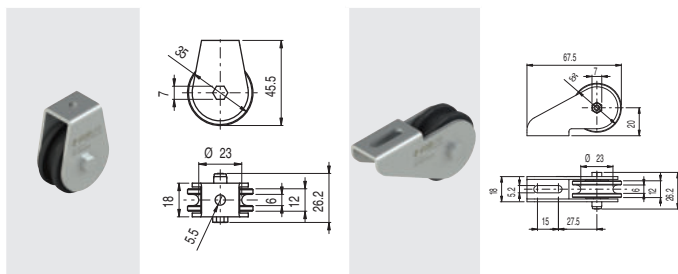

Safety springs

Article	Description	Article	Description
VF AF-ME78	Safety spring in stainless steel	VF AF-ME80	Safety spring in stainless steel

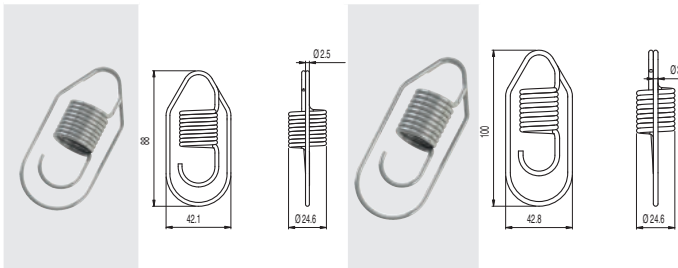

For switches with longitudinal head

For switches with transversal head



LED signalling lights

Article	Description
VF SL1A2PA1	White, 24 Vac/dc
VF SL1A3PA1	Red, 24 Vac/dc
VF SL1A4PA1	Green, 24 Vac/dc
VF SL1A5PA1	Yellow, 24 Vac/dc



These LED signalling lights are used for signalling that an electric contact has changed its state inside the switch. They can be installed on switches by screwing them on one of the conduit entries not used for electric cables. For details see page 374.

Function indicators

Article	Engraving	Language	Notes
VF AF-IF1GR00			
VF AF-IF1GR01	STOP EMERGENZA	ita	
VF AF-IF1GR02	EMERGENCY STOP	eng	
VF AF-IF1GR03	STOP	eng	
VF AF-IF1GR04	NOT - AUS	deu	
VF AF-IF1GR05	ARRET D'URGENCE	fra	
VF AF-IF1GR06	PARADA DE EMERGENCIA	esp	
VF AF-IF1GR07	NODSTOP	dan	
VF AF-IF1GR08	Ⓢ STOP Ⓢ	eng	
VF AF-IF1GR11	Ⓢ Ⓢ		In compliance with EN ISO 13850



Rope function indicators in conformity with standard EN ISO 13850.

Ropes and further accessories

Article	Description	Weight (Kg)
VF F05-100	100 m of rope on spool	5.1
VF F05-035	35 m of rope on spool	1.8
VF F05-020	20 m of rope, loose	1.0
VF F05-010	10 m of rope, loose	0.5



Zinc-plated steel rope coated with red plastic covering, 5 mm diameter.

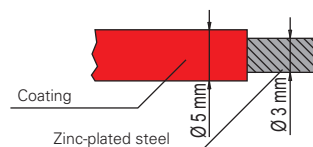

The rope is robust and has long-lasting protection against mechanical damage and corrosion.

Article	Description
VF F05-400	Rope

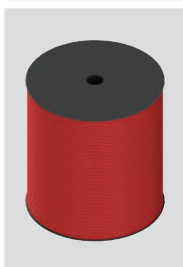

400 m spool of zinc-plated steel rope coated with red plastic covering, 5 mm diameter.

Weight 20.5 Kg.

Article	Description
VF F05-500B	Rope

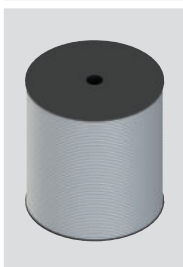

500 m spool of zinc-plated steel rope coated with white plastic covering, 5 mm diameter.

Weight 25.6 Kg.

Article	Description
VF SB400	Rope dispenser



Rope dispenser for 400 m and 500 m spools. This rope dispenser makes it easy to unroll the rope without tangles.

Article	Description
VF SFP2	Ceiling fixing plate



Metal fixing plate, for fixing rope switches on the ceiling.

The plate is provided with bore holes for fastening switches of the series. It is supplied without screws.

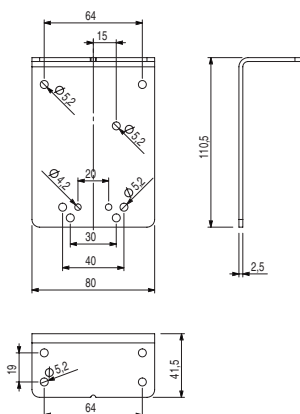

Accessory sets for rope installation - FAST line

Practical installation set containing stay bolts and rope in the same package.



Article	Set content
VF AF-KT10M0	1x VF AF-TR5 1x VF AF-MR5 1x VF F05-010
VF AF-KT20M0	1x VF AF-TR5 1x VF AF-MR5 1x VF F05-020
VF AF-KT35M0	1x VF AF-TR5 1x VF AF-MR5 1x VF F05-035

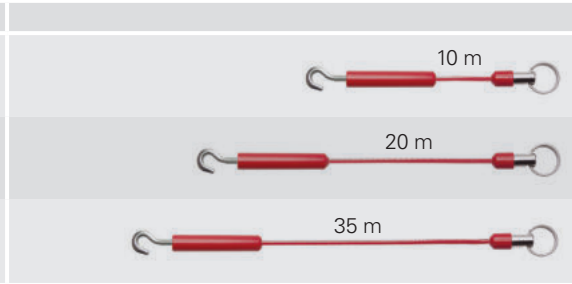

Article	Set content
VF AF-KM10R0	1x VF AF-MR5 1x VF AF-TR8 1x VF F05-010
VF AF-KM20R0	1x VF AF-MR5 1x VF AF-TR8 1x VF F05-020
VF AF-KM35R0	1x VF AF-MR5 1x VF AF-TR8 1x VF F05-035

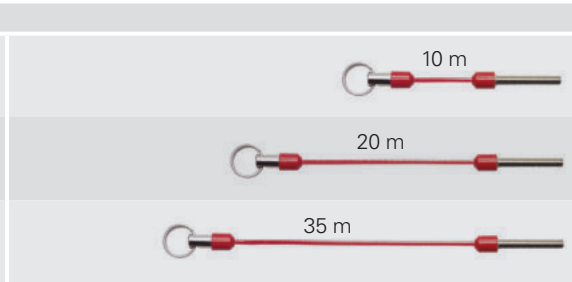

Article	Set content
VF AF-KT10M7	1x VF AF-TR5 1x VF AF-MR5 1x VF F05-010 1x VF AF-ME78
VF AF-KT20M8	1x VF AF-TR5 1x VF AF-MR5 1x VF F05-020 1x VF AF-ME80
VF AF-KT35M8	1x VF AF-TR5 1x VF AF-MR5 1x VF F05-035 1x VF AF-ME80

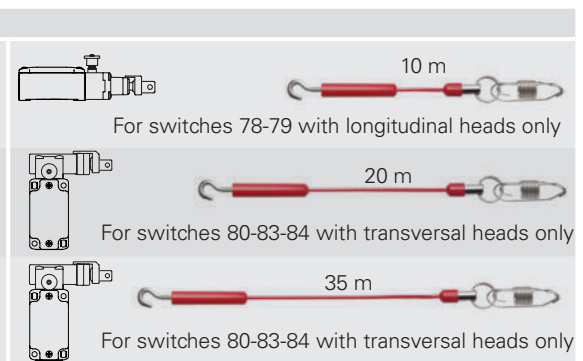

Combination examples

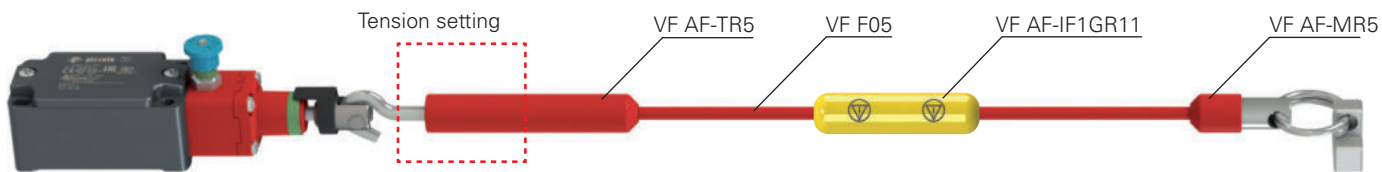

This combination of accessories is suitable for medium rope lengths, where the two rope ends are far away from each other.

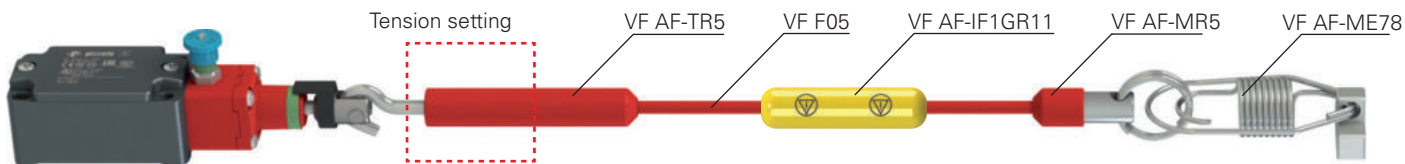

This combination of accessories is suitable for medium-high rope lengths (thanks to VF AF-ME78 safety spring) and where the two rope ends are far away from each other.

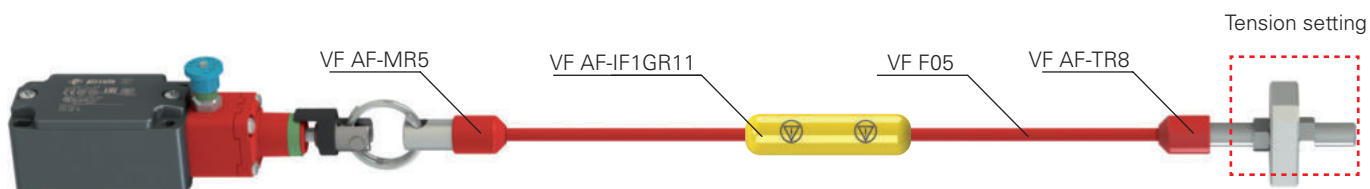

This combination of accessories is suitable for medium rope lengths or where the two rope ends are close to each other.

A Installation of adjustable stay bolt VF AF-TR5

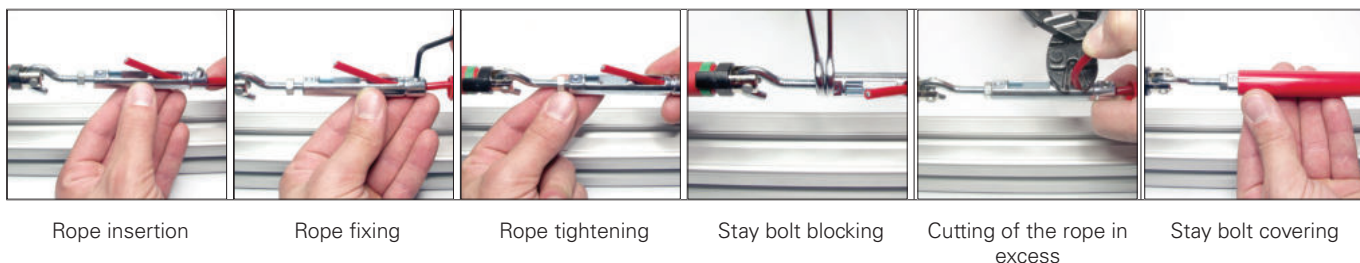

Rope insertion

Rope fixing

Rope tightening

Stay bolt blocking

Cutting of the rope in excess

Stay bolt covering

B Installation of adjustable stay bolt VF AF-TR8

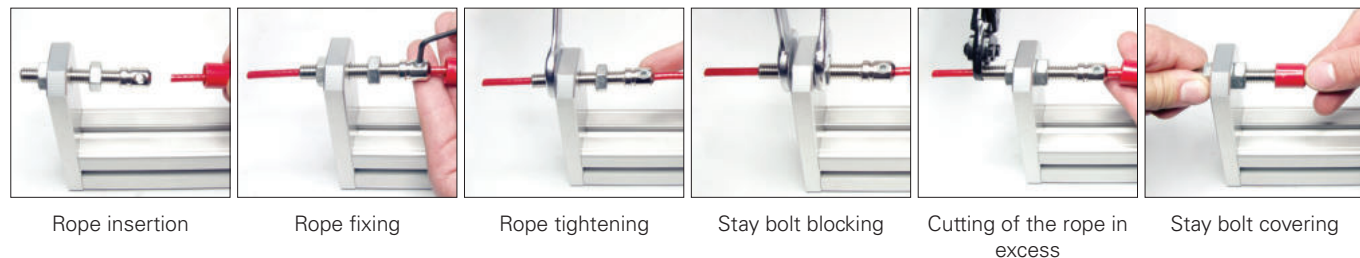

Rope insertion

Rope fixing

Rope tightening

Stay bolt blocking

Cutting of the rope in excess

Stay bolt covering

C Installation of end clamp VF AF-MR5

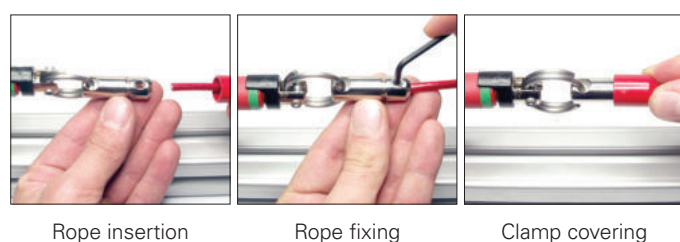

Rope insertion

Rope fixing

Clamp covering

Application example: possibility of emergency stop along the whole perimeter of the machine with rope supported by angular pulleys



Angular pulley
Article: VF AF-CA10

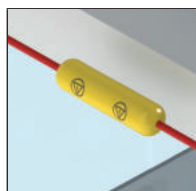

Function indicator
Article: VF AF-IF1GR11



Safety module
Example: CS AR-20V024

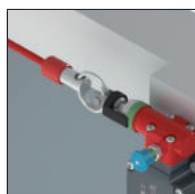

End clamp
Article: VF AF-MR5

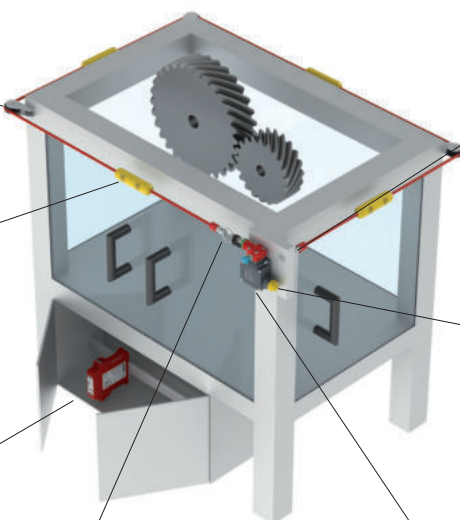

Stay bolt
Article: VF AF-TR8



Signalling light
Article: VF SL1A5PA1

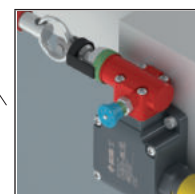

Safety rope switch
Article: FL 1883-M2

Application example: availability of emergency stop along the frontal section of the machine

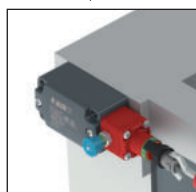
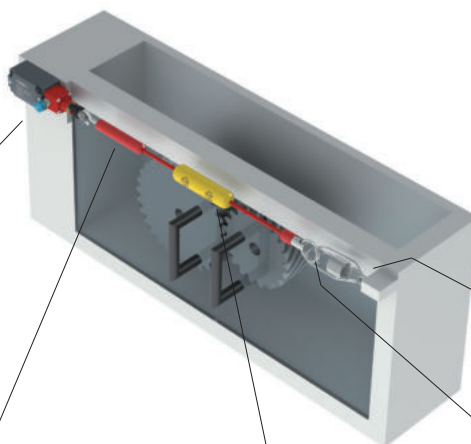

Safety rope switch
Article: FD 1878-M2



Adjustable stay bolt
Article: VF AF-TR5

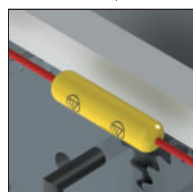

Function indicator
Article:
VF AF-IF1GR11

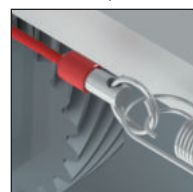

End clamp
Article: VF AF-MR5



Safety spring
Article: VF AF-ME78

Any information or application example, connection diagrams included, described in this document are to be intended as purely descriptive.
The choice and application of the products in conformity with the standards, in order to avoid damage to persons or goods, is the user's responsibility.

